



- Continuous monitoring of correct grounding
- Robust design
- Weather-protected stainless steel enclosure (IP66)
- One potential-free change-over contact for signalling to the distributed control system or external signalling devices
- Insulated suspension point

A7

MY R. STAHL 8150G



The grounding monitoring device ensures that tank containers, barrels, road tankers, rail vehicles and IBCs are electrostatically grounded while combustible liquids and powders are being loaded. The device simultaneously monitors electrostatic grounding.

This guarantees that an electrostatic charge remains at a safe level and that there is no explosion hazard caused by the uncontrolled discharge of this energy.

	IECEX / ATEX					
Zone	0	1	2	20	21	22
Ex interface		•	•		•	
Installation in		•	•		•	•





Selection Table

Product description	Grounding monitoring device			
Enclosure material	Product Type	Art. No.	Weight	
Stainless steel 1.4404	8150/5-V75	256498	6.58 kg	

Technical Data

Explosion Protection	
IECEX gas explosion protection	Ex db eb [ia Ga] IIC T4 Gb
IECEX dust explosion protection	Ex tb [ia Da] IIIC T80 °C Db
ATEX gas explosion protection	Ⓔ II 2(1) G Ex db eb [ia Ga] IIC T4 Gb
ATEX dust explosion protection	Ⓔ II 2 (1) D Ex tb [ia Da] IIIC T80 °C Db
Certificates	ATEX (PTB), Brazil (ULB), China (NEPSI), IECEX (PTB), India (PESO), SIL (exida), Taiwan (ITRI)
Declaration of conformity	ATEX (EUK), China (CCC)
Safety Data	
Safety-related max. voltage	253 V
Electrical Data	
Frequency range	48 – 62Hz
Auxiliary Power	
Nominal voltage range AC	96 – 253 V
Nominal current	27 mA
Power consumption	3 W
Output	
Limit contact	Change-over contact

Technical Data	
Output	
Min. output load condition	12 V / 100 µA
Max. output DC load condition	250 V / 2 A
Max. output AC load condition	250 V / 4 A
Ambient Conditions	
Ambient temperature	-20 °C ... 55 °C
Storage temperature	-40 °C ... 80 °C
Mechanical Data	
Degree of protection (IP)	IP66

Accessories			
Figure	Description	Art. No.	Weight
Grounding clamp with cable			
	10 m oil- and petrol-resistant cable with robust, ergonomic grounding clamp made from stainless steel, and fast-action plug Installation in Zone 1, IIC, T6; Zone 21, IIIC, 135 °C Temperature range: -40 °C to +70 °C Certificates: ATEX, IECEx	247673	2.9 kg
Grounding clamp with spiral cable			
	10 m oil- and petrol-resistant spiral cable with robust, ergonomic grounding clamp made from stainless steel, and fast-action plug Installation in Zone 1, IIC, T6; Zone 21, IIIC, 135 °C Temperature range: -40 °C to +70 °C Certificates: ATEX, IECEx	247674	4 kg
	5 m oil- and petrol-resistant spiral cable with robust, ergonomic grounding clamp made from stainless steel, and fast-action plug Installation in Zone 1, IIC, T6; Zone 21, IIIC, 135 °C Temperature range: -40 °C to +70 °C Certificates: ATEX, IECEx	247672	1.5 kg
Grounding clamp with automatic retractor for cable			
	Self retracting reel with 20 m oil- and petrol-resistant cable with robust, ergonomic grounding clamp made from stainless steel, and fast-action plug, aluminium enclosure, protected cable duct with stopper Installation in Zone 1, IIC, T6; Zone 21, IIIC, 135 °C Temperature range: -40 °C to +70 °C Degree of protection (IP): IP43 Certificates: ATEX, IECEx	247671	14.5 kg
	Self retracting reel with 12 m oil- and petrol-resistant cable with robust, ergonomic grounding clamp made from stainless steel, and fast-action plug, aluminium enclosure, protected cable duct with stopper Installation in Zone 1, IIC, T6; Zone 21, IIIC, 135 °C Temperature range: -40 °C to +70 °C Degree of protection (IP): IP42 Certificates: ATEX, IECEx	269915	6.2 kg
	Self retracting reel with 9 m oil- and petrol-resistant cable with robust, ergonomic grounding clamp made from stainless steel, and fast-action plug, plastic enclosure Roofing must be provided when installing the unit outside. Installation in Zone 1, IIC, T6; Zone 21, IIIC, 135 °C Temperature range: -20 °C to +70 °C Degree of protection (IP): IP42 Certificates: ATEX, IECEx	247660	4.5 kg

Spare Parts			
Figure	Description	Art. No.	Weight
Grounding clamp with fast-action plug			
	Robust, ergonomic grounding clamp with 150 mm cable and fast-action plug Spare part for self retracting reels (247660, 269915 and 247671), cable and spiral cable	247675	600 g

Dimensional Drawings (All Dimensions in mm [inches]) – Subject to Alterations

A7

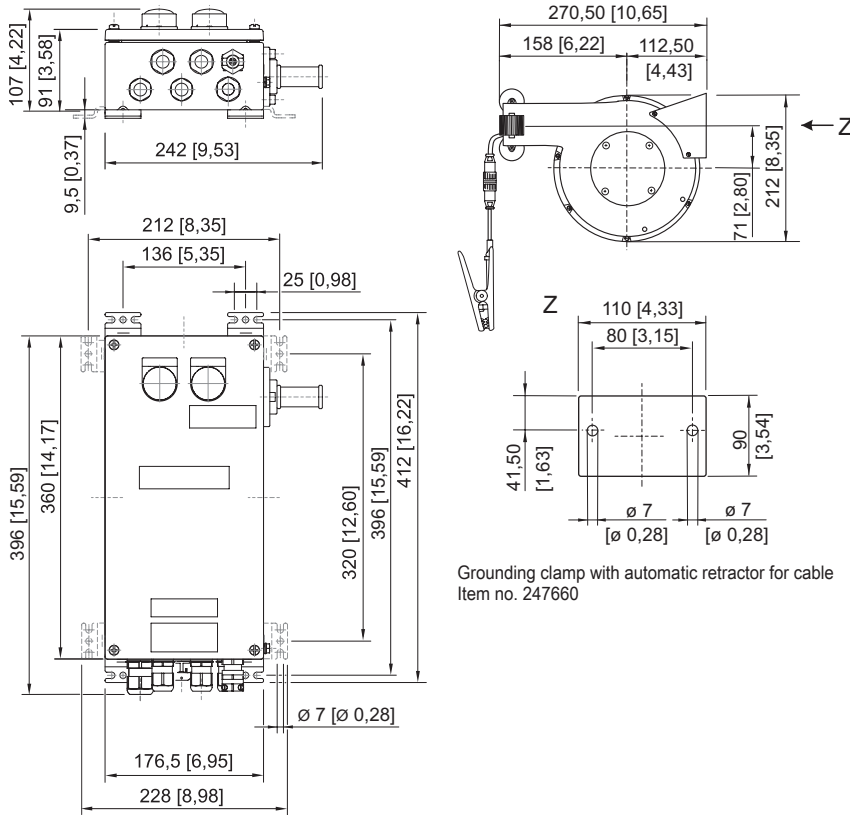

Grounding clamp with automatic retractor for cable
Item no. 247660

Type 8150/5-V75

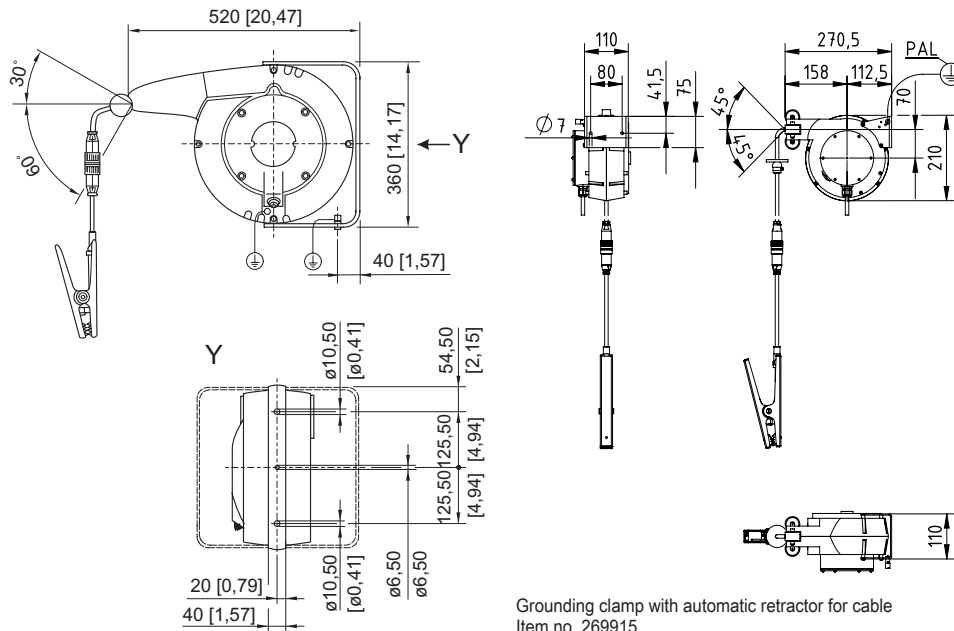

Grounding clamp with automatic retractor for cable
Item no. 247671

Grounding clamp with automatic retractor for cable
Item no. 269915