

- Ex e enclosure series made of stainless steel
- Ideally suited for terminal boxes
- 14 different standard sizes
- Cover with screws or with hinge
- Available as Ex e empty enclosure or customised as Ex e terminal box

E9

MY R. STAHL 8151A



Ex e enclosure made of high-quality 1.4404 stainless steel, specially designed for use as a terminal box. 14 standard sizes with 1 mm/1.2mm thickness, optionally with screw-on cover or hinge with screws or cam locks, offer great flexibility for a wide range of applications. Can be customised with terminal blocks from various manufacturers, as well as a large selection of cable glands, cable entries, mounting and flange plates. The enclosures in the 8151 series are available as empty enclosures with U-certification or as fully certified Ex e terminal boxes.

	IECEX / ATEX					
Zone	0	1	2	20	21	22
Installation in		•	•		•	•

Selection Table							
Product description Cover		Empty enclosure Hinge / cam lock					
Width	Height	Depth	Product Type	Art. No.	Weight		
176.5 mm	236.5 mm	91 mm	8151/0-061A-3321	324619	2.5 kg		
		91 mm	8151/0-071A-3321	324620	3.1 kg		
		150 mm	8151/0-073A-3321	324621	3.6 kg		
360 mm	360 mm	91 mm	8151/0-081D-3321	324622	4.5 kg		
		150 mm	8151/0-083D-3321	324623	5.1 kg		
		230 mm	8151/0-086D-3321	324624	6 kg		
	727 mm	91 mm	91 mm	8151/0-091A-3321	324625	7.2 kg	
			150 mm	8151/0-093A-3321	324626	8.3 kg	
			230 mm	8151/0-096A-3321	324627	9.5 kg	
400 mm	600 mm	150 mm	8151/0-113A-3321	324628	8.9 kg		
		230 mm	8151/0-116A-3321	324629	10.4 kg		
760 mm	760 mm	230 mm	8151/0-126D-3321	324630	19.9 kg		
		300 mm	8151/0-128D-3321	324631	22 kg		
Product description Cover		Empty enclosure Hinge / screw-on cover					
Width	Height	Depth	Product Type	Art. No.	Weight		
176.5 mm	176.5 mm	91 mm	8151/0-051D-3331	324632	2 kg		
	236.5 mm	91 mm	8151/0-061A-3331	324633	2.3 kg		
	360 mm	91 mm	8151/0-071A-3331	324634	3 kg		
		150 mm	8151/0-073A-3331	324635	3.5 kg		

Selection Table

Product description Cover		Empty enclosure Hinge / screw-on cover			
Width	Height	Depth	Product Type	Art. No.	Weight
360 mm	360 mm	91 mm	8151/0-081D-3331	324636	4.3 kg
		150 mm	8151/0-083D-3331	324637	5 kg
		230 mm	8151/0-086D-3331	324638	5.9 kg
	727 mm	91 mm	8151/0-091A-3331	324639	7.1 kg
		150 mm	8151/0-093A-3331	324640	8.1 kg
		230 mm	8151/0-096A-3331	324641	9.5 kg
400 mm	600 mm	150 mm	8151/0-113A-3331	324642	8.7 kg
		230 mm	8151/0-116A-3331	324643	10.3 kg
760 mm	760 mm	230 mm	8151/0-126D-3331	324644	19.9 kg
		300 mm	8151/0-128D-3331	324645	21.9 kg

Product description Cover		Empty enclosure Screw-on cover			
Width	Height	Depth	Product Type	Art. No.	Weight
116.5 mm	176.5 mm	91 mm	8151/0-041A-3311	324604	1.7 kg
176.5 mm	176.5 mm	91 mm	8151/0-051D-3311	324605	1.9 kg
	236.5 mm	91 mm	8151/0-061A-3311	324606	2.3 kg
	360 mm	91 mm	8151/0-071A-3311	324607	3 kg
360 mm	360 mm	150 mm	8151/0-073A-3311	324608	3.4 kg
		91 mm	8151/0-081D-3311	324609	4.3 kg
		150 mm	8151/0-083D-3311	324610	5 kg
		230 mm	8151/0-086D-3311	324611	5.9 kg
360 mm	727 mm	91 mm	8151/0-091A-3311	324612	7 kg
		150 mm	8151/0-093A-3311	324613	8 kg
		230 mm	8151/0-096A-3311	324614	9.3 kg
		150 mm	8151/0-113A-3311	324615	8.7 kg
400 mm	600 mm	230 mm	8151/0-116A-3311	324616	10.1 kg
		230 mm	8151/0-126D-3311	324617	19.9 kg
760 mm	760 mm	230 mm	8151/0-126D-3311	324617	19.9 kg
		300 mm	8151/0-128D-3311	324618	21.9 kg

Technical Data

Variant	Cover: Hinge / cam lock 8151/0-...A-3321	Cover: Hinge / screw-on cover 8151/0-...A-3331	Cover: Screw-on cover 8151/0-...A-3311
Explosion Protection			
Area of application	European Union (ATEX) IECEX	European Union (ATEX) IECEX	European Union (ATEX) IECEX
IECEX gas explosion protection	Ex eb IIC Gb	Ex eb IIC Gb	Ex eb IIC Gb
IECEX dust explosion protection	Ex tb IIIC Db	Ex tb IIIC Db	Ex tb IIIC Db
ATEX gas explosion protection	⊕ II 2 G Ex eb IIC Gb	⊕ II 2 G Ex eb IIC Gb	⊕ II 2 G Ex eb IIC Gb
ATEX dust explosion protection	⊕ II 2 D Ex tb IIIC Db	⊕ II 2 D Ex tb IIIC Db	⊕ II 2 D Ex tb IIIC Db
Certificates	ATEX (BVS), IECEX (BVS)	ATEX (BVS), IECEX (BVS)	ATEX (BVS), IECEX (BVS)
Ambient Conditions			
Ambient temperature	-60 °C ... +135 °C	-60 °C ... +135 °C	-60 °C ... +135 °C
Ambient temperature	-76 °F ... +275 °F	-76 °F ... +275 °F	-76 °F ... +275 °F
Mechanical Data			
Degree of protection (IP) (IEC 60529)	IP66	IP66	IP66
Enclosure material	Stainless steel 1.4404, Brush finished	Stainless steel 1.4404, Brush finished	Stainless steel 1.4404, Brush finished
Silicone-free	No	No	No
Cover fixing type	Cam lock, With side C hinge	With captive screws, With side C hinge	With captive screws
Impact strength (IEC 60079)	7 J	7 J	7 J

Technical Data			
Variant	Cover: Hinge / cam lock 8151/0-...A-3321	Cover: Hinge / screw-on cover 8151/0-...A-3331	Cover: Screw-on cover 8151/0-...A-3311
Mechanical Data			
Impact strength (IEC 62262)	IK09	IK09	IK09
Mounting / Installation			
Tightening torque of cover screw 1		4.5 N · m	4.5 N · m
Tightening torque of cover screw 1 lbf in	0 lbf in	39.83 lbf in	39.83 lbf in

Dimensional Drawings (All Dimensions in mm [inches]) – Subject to Alterations

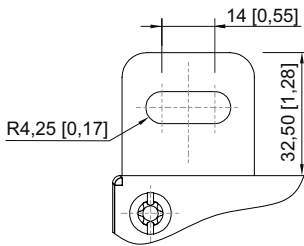

Mounting bracket top

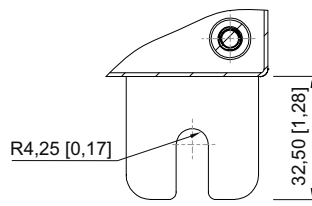

Mounting bracket below

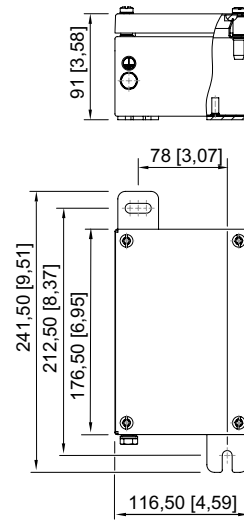

8151/0-041A-3311

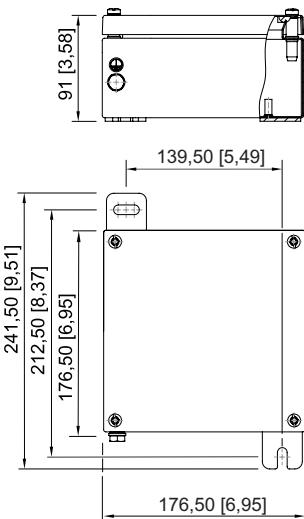

8151/0-051A-3311

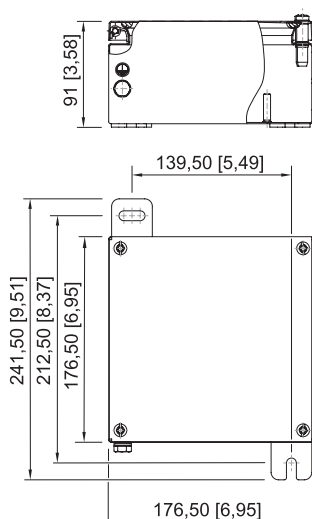

8151/0-051A-3331

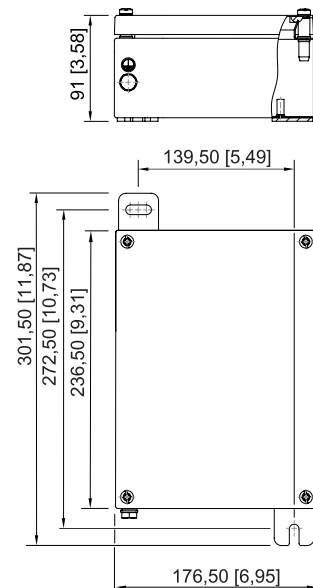

8151/0-061A-3311

E9

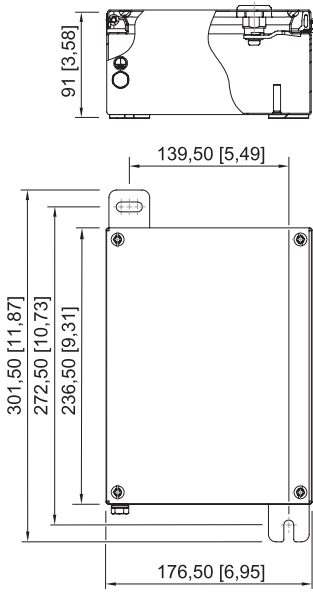

8151/0-061A-3321

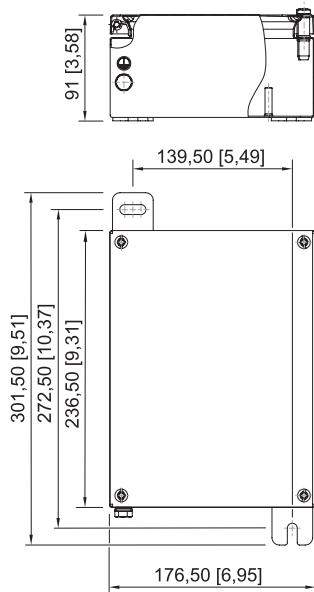

8151/0-061A-3331

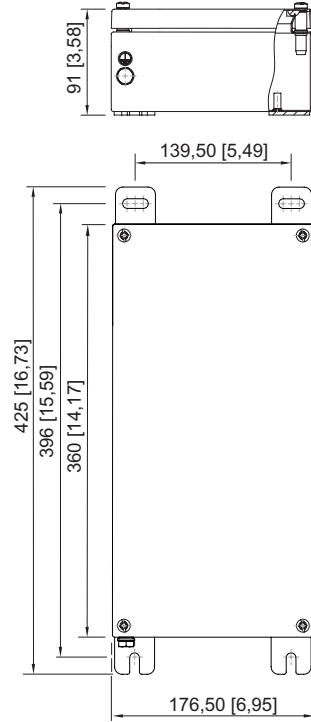

8151/0-071A-3311

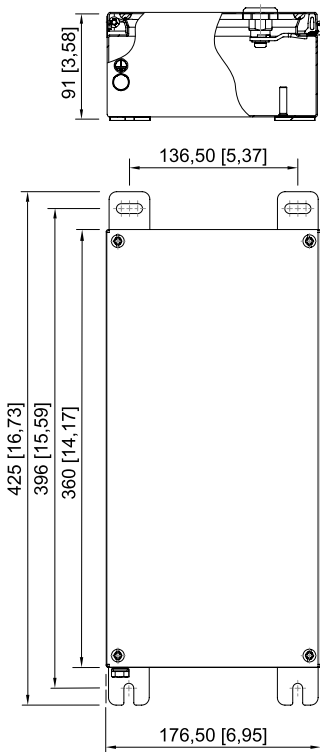

8151/0-071A-3321

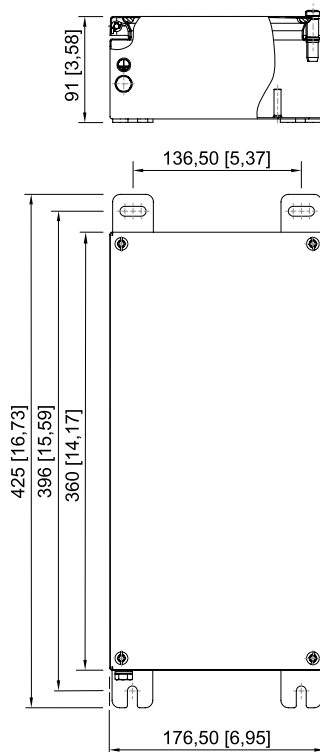

8151/0-071A-3331

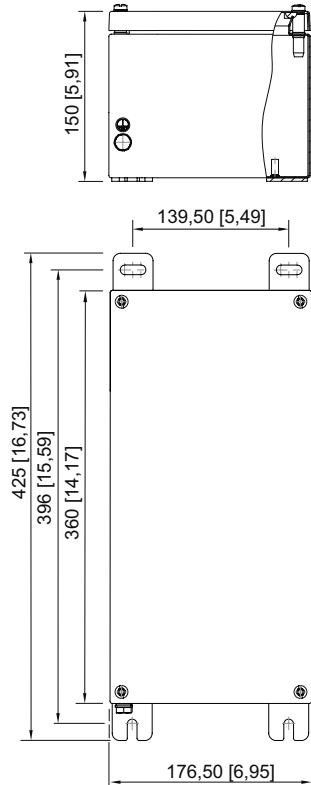

8151/0-073A-3311

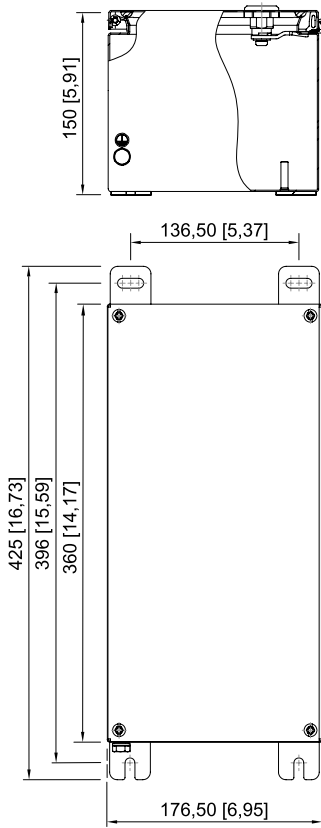

8151/0-073A-3321

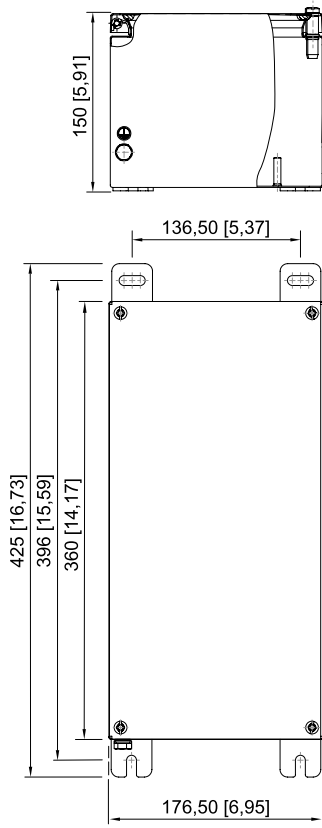

8151/0-073A-3331

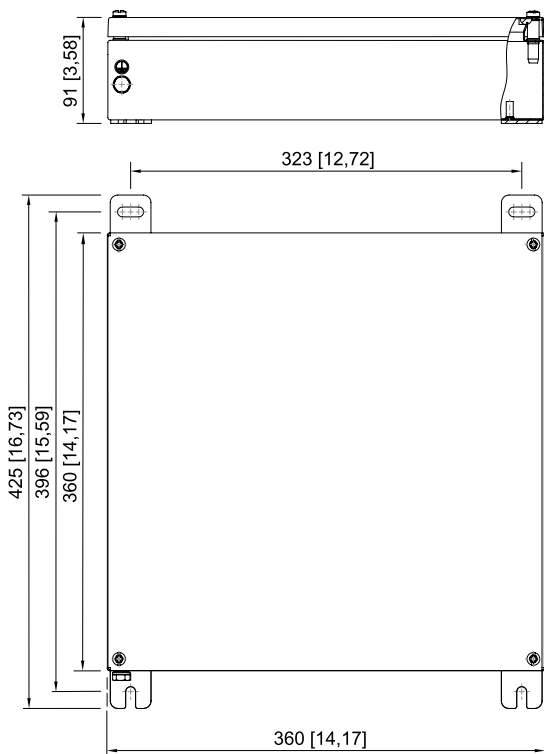

8151/0-081A-3311

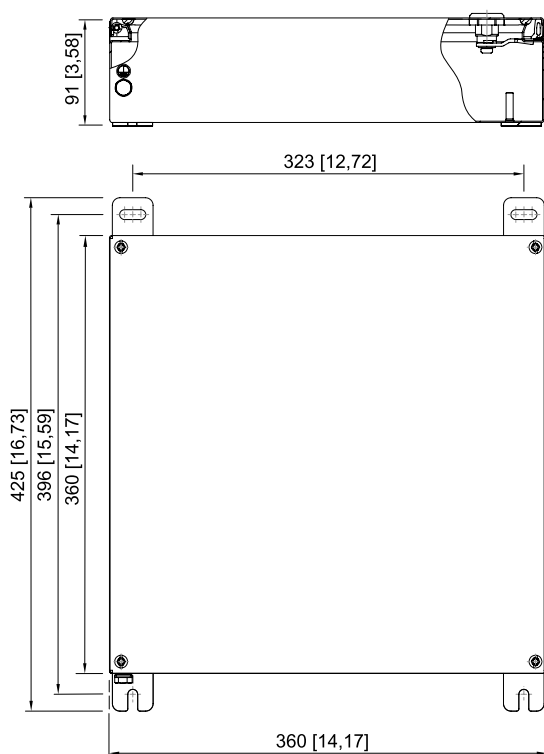

8151/0-081A-3321

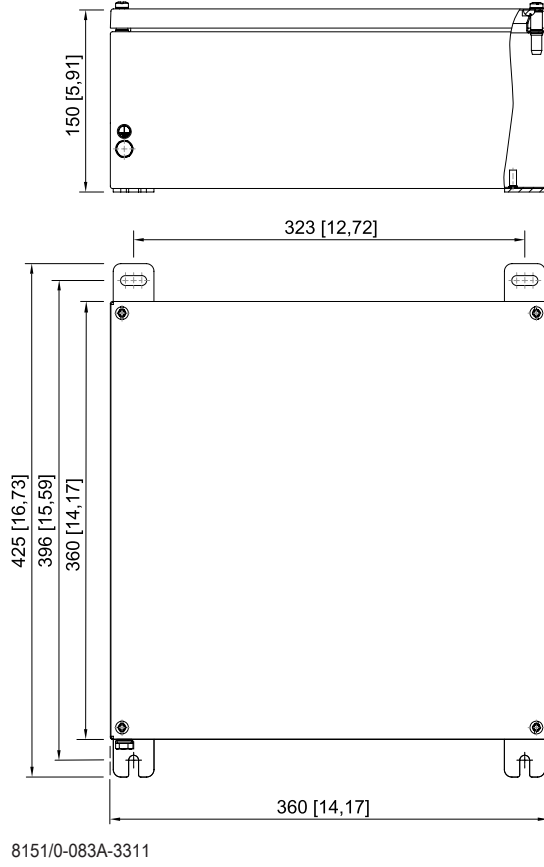
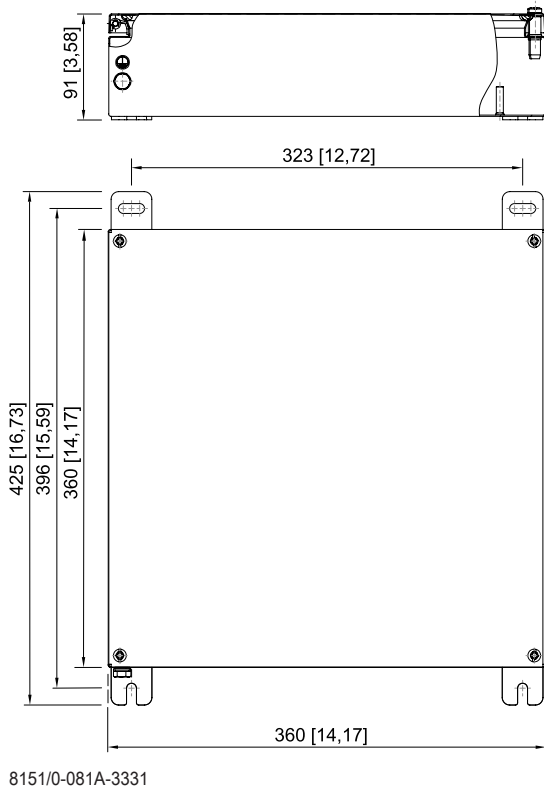

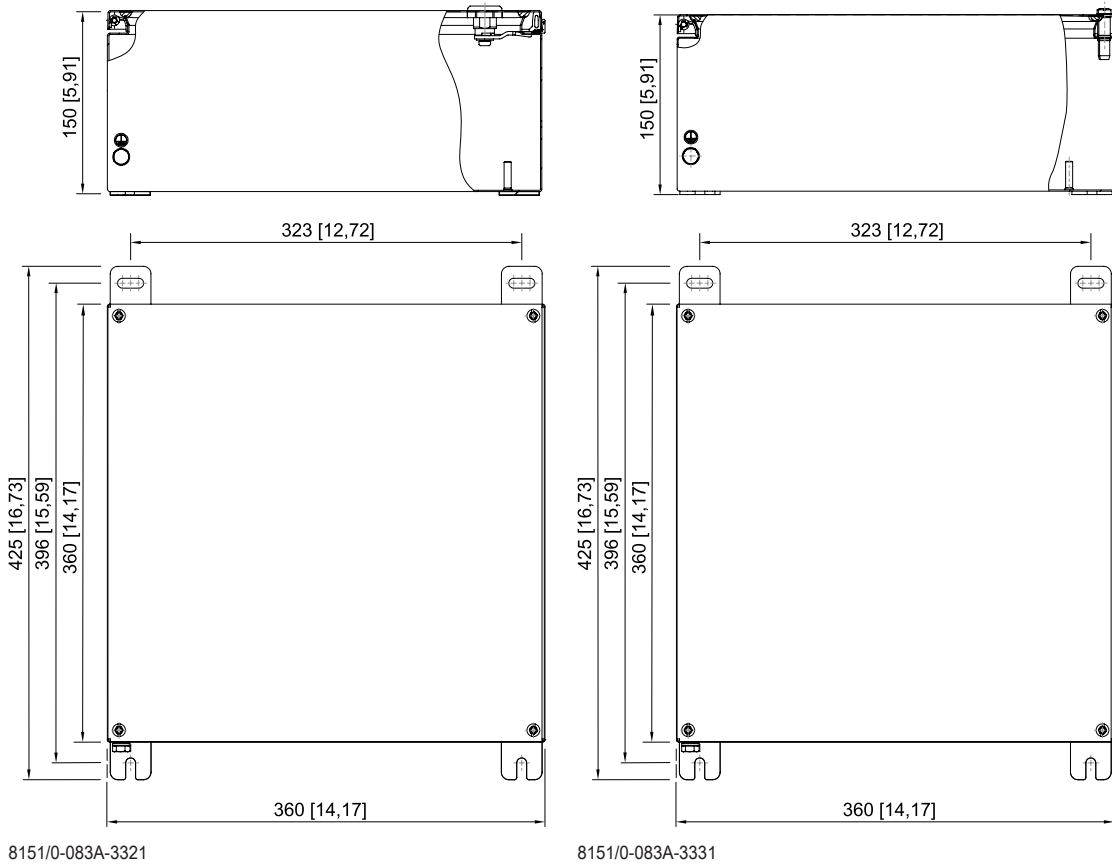

E9

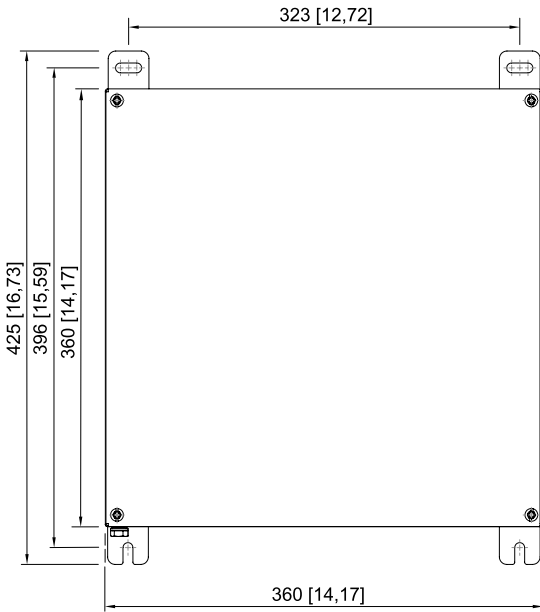
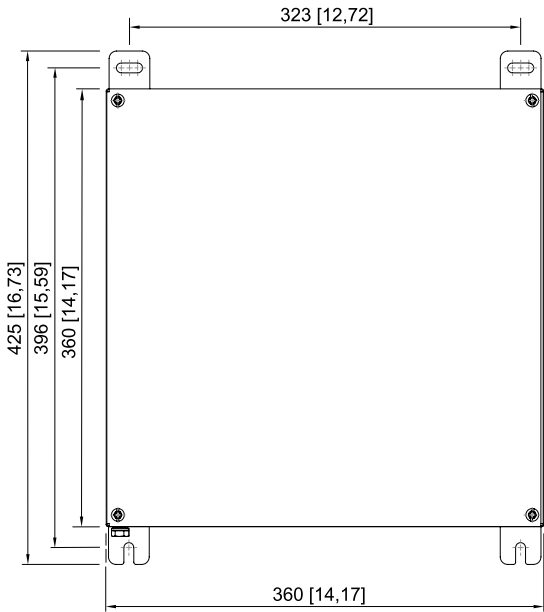
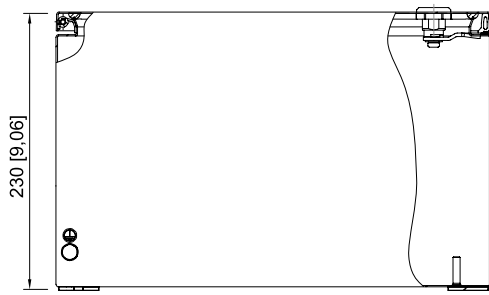
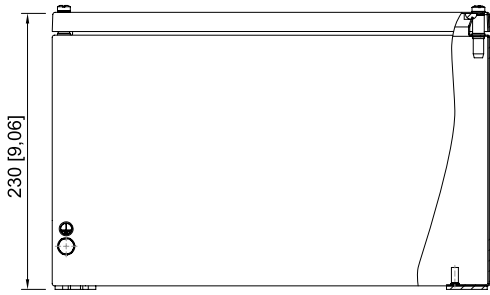

8151/0-086A-3311

8151/0-086A-3321

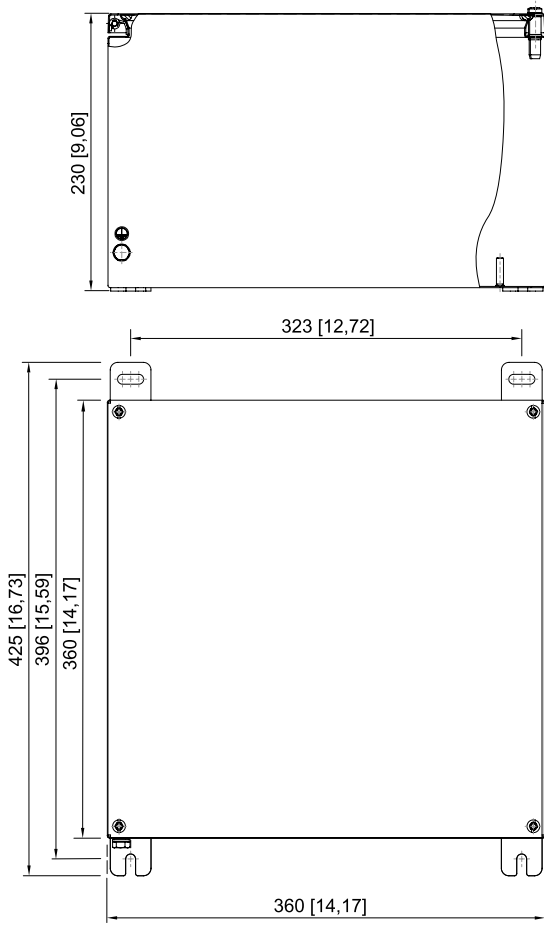

8151/0-086A-3331

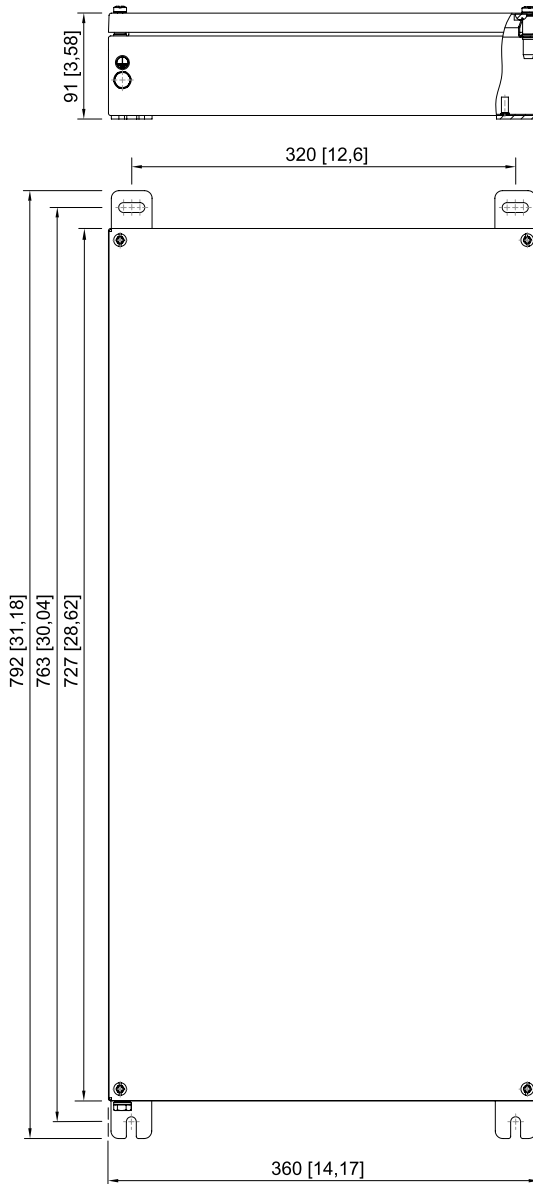

8151/0-091A-3311

E9

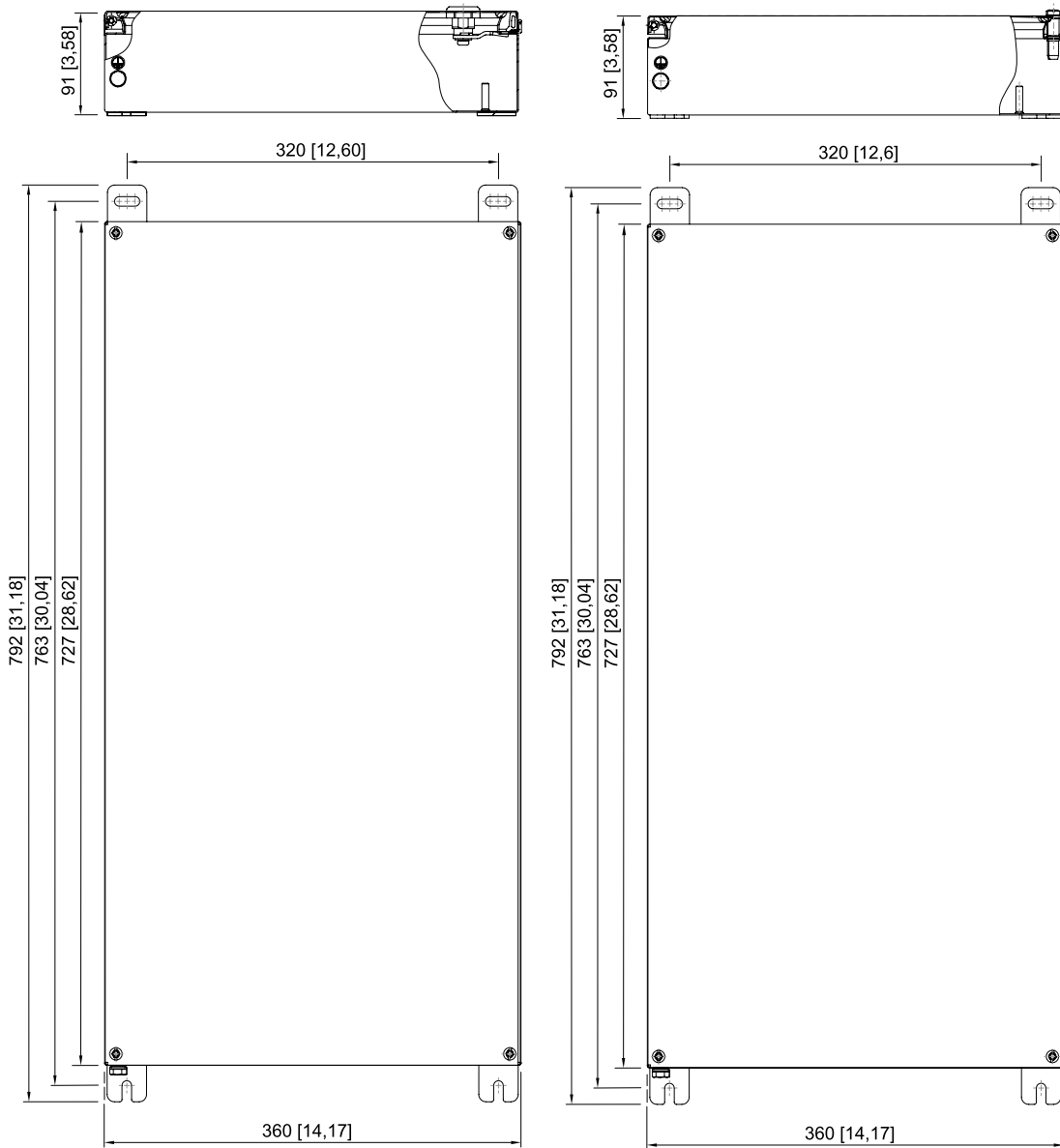

8151/0-091A-3321

8151/0-091A-3331

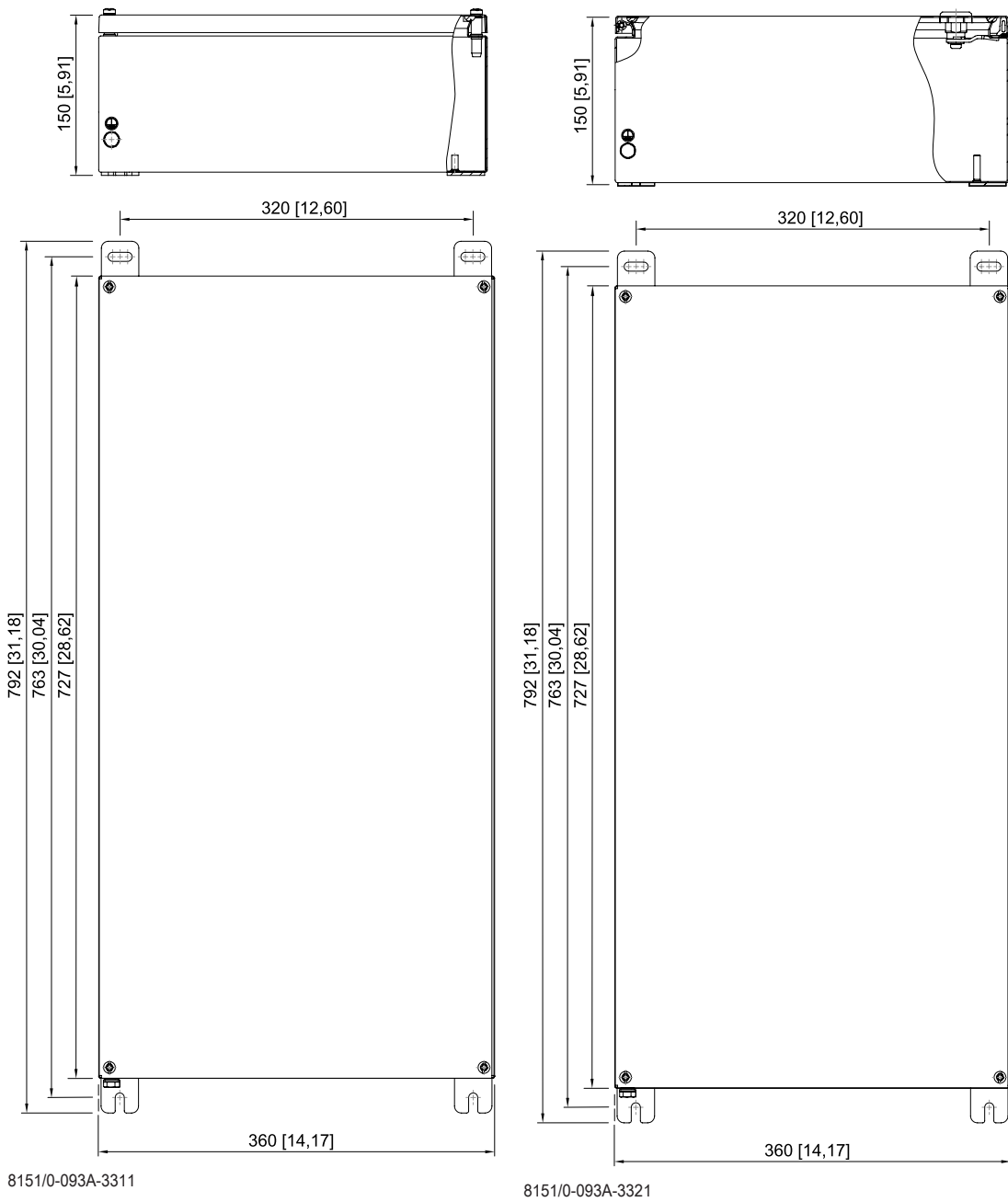

E9

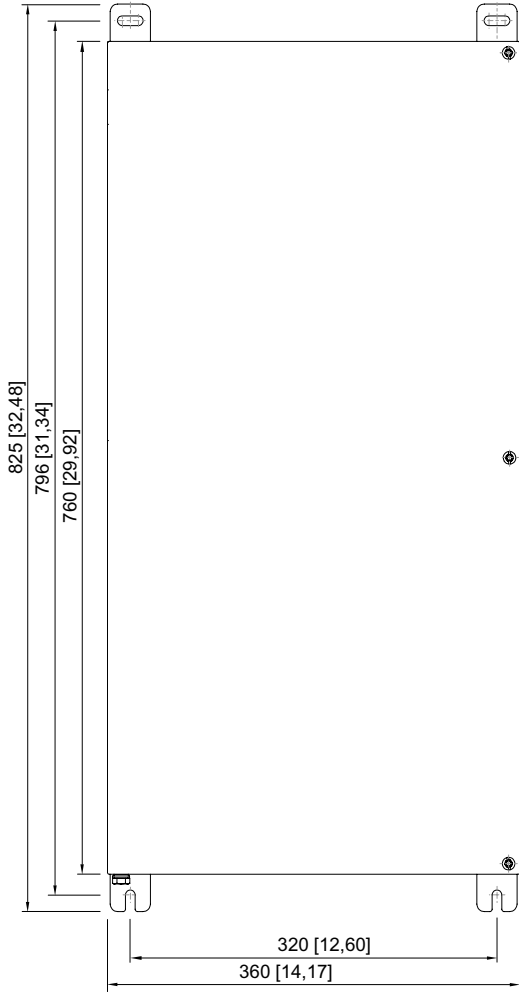
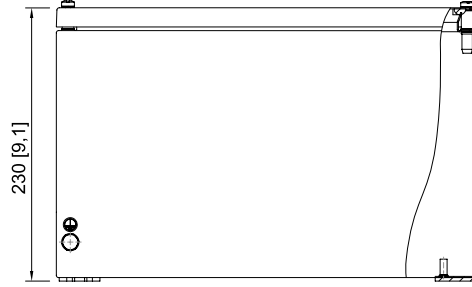
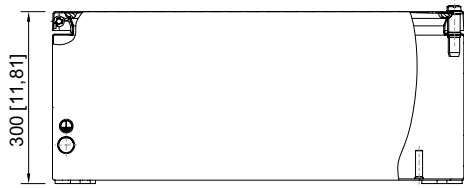

8151/0-093A-3331

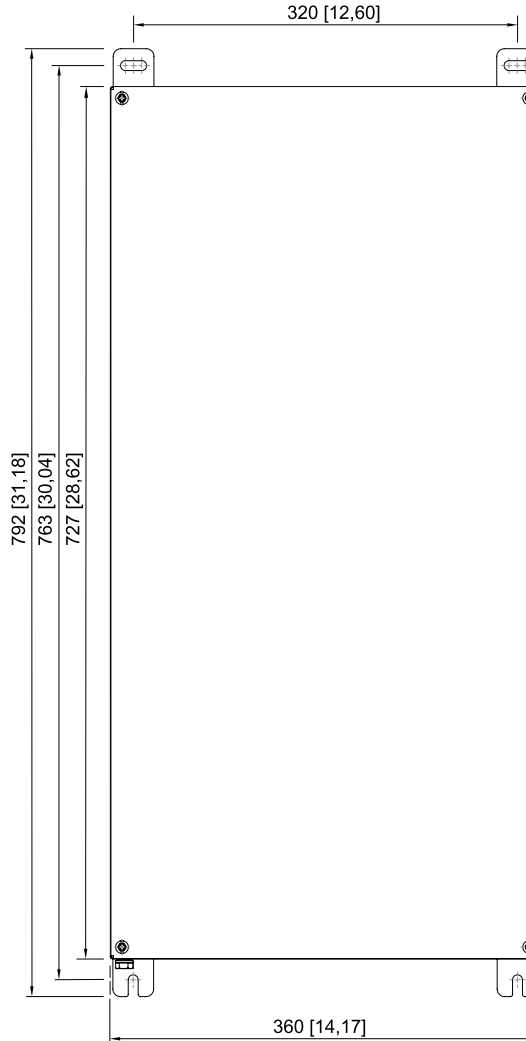

8151/0-096A-3311

Ex e enclosure made of stainless steel

Series 8151



E9

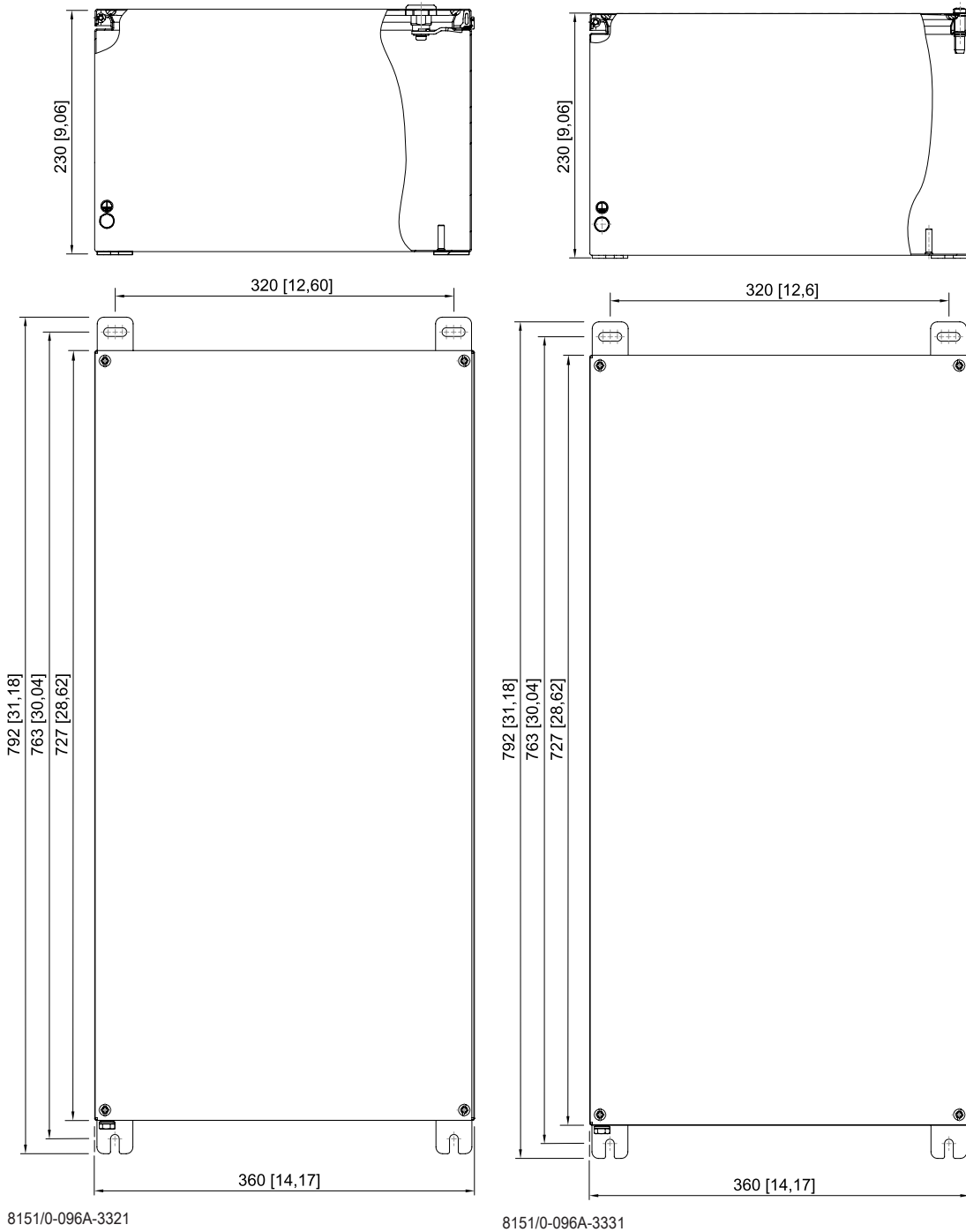

8151/0-096A-3321

8151/0-096A-3331

E9

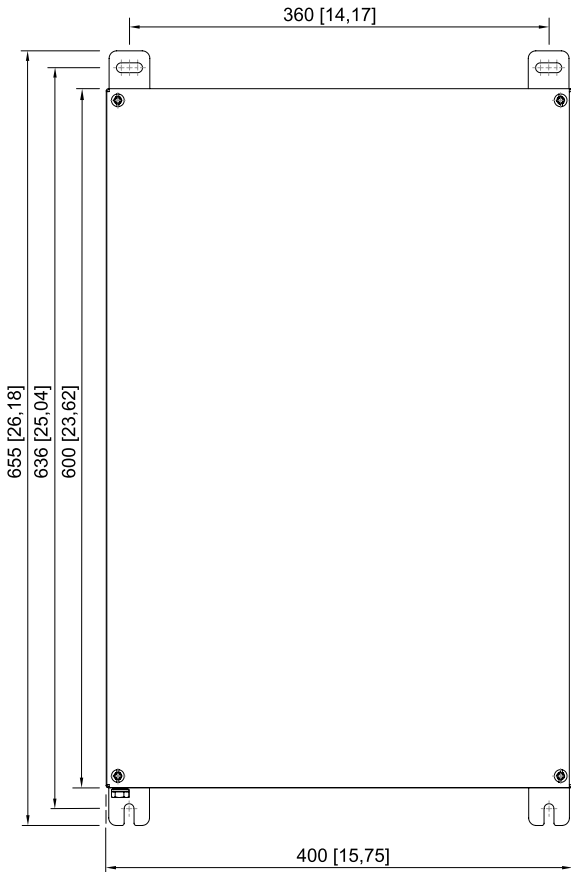
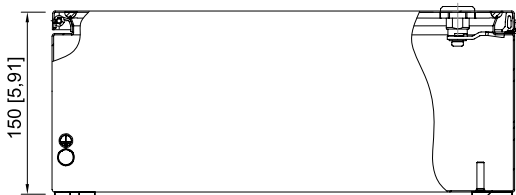
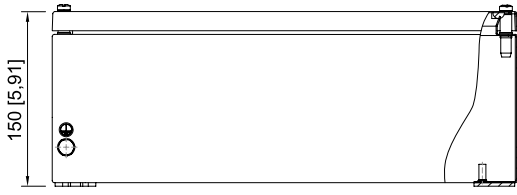

8151/0-113A-3311

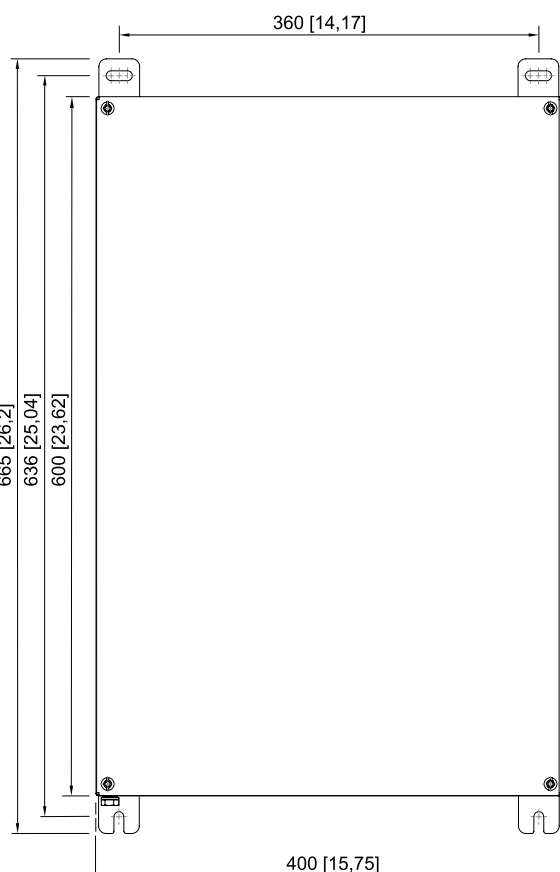

8151/0-113A-3321

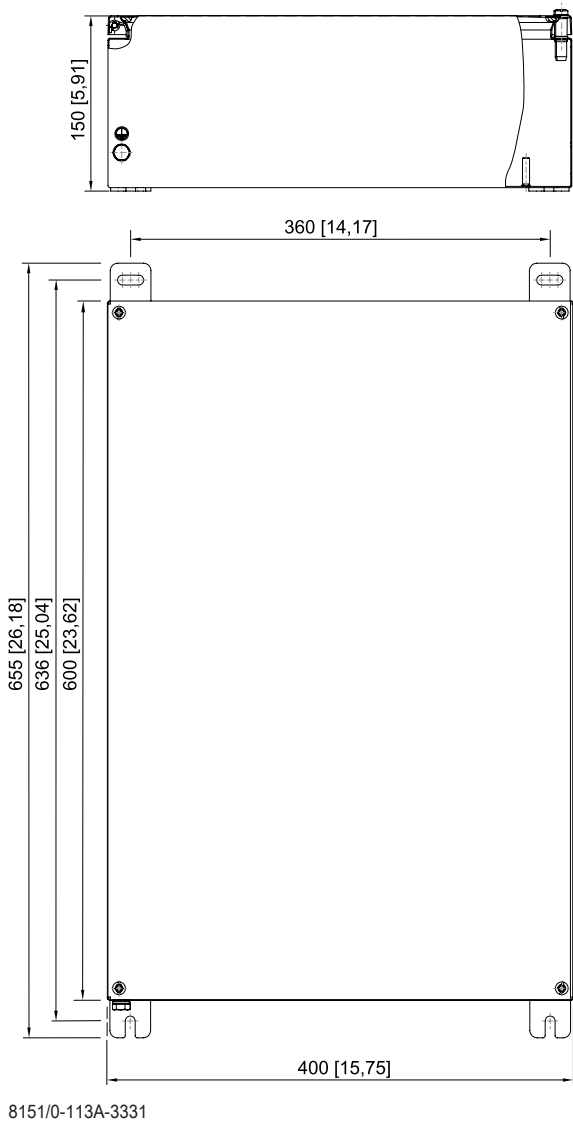

8151/0-113A-3331

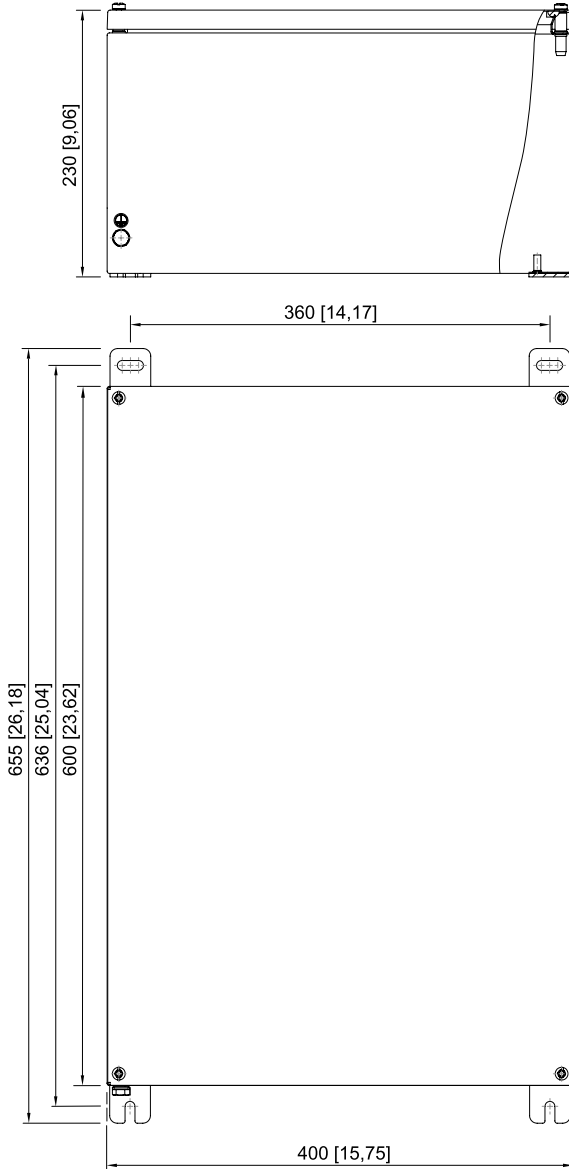

8151/0-116A-3311

E9

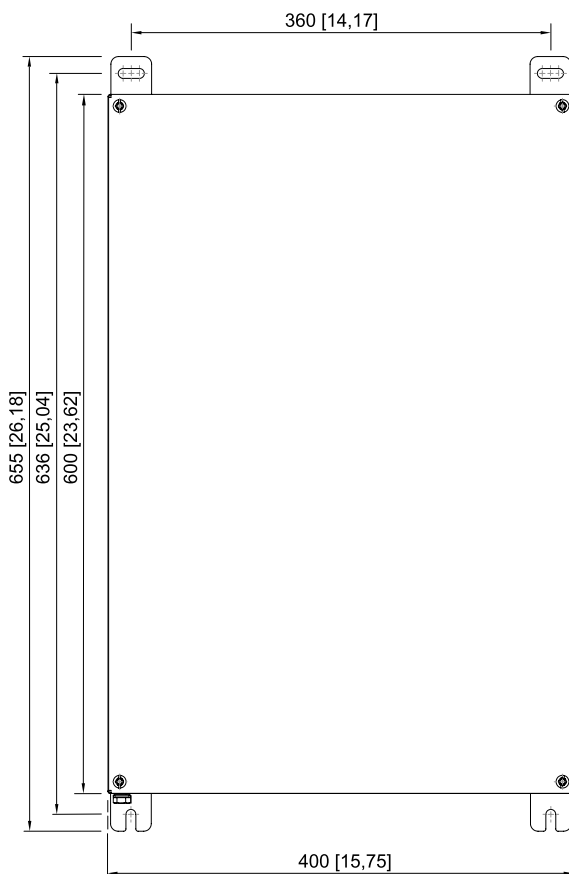
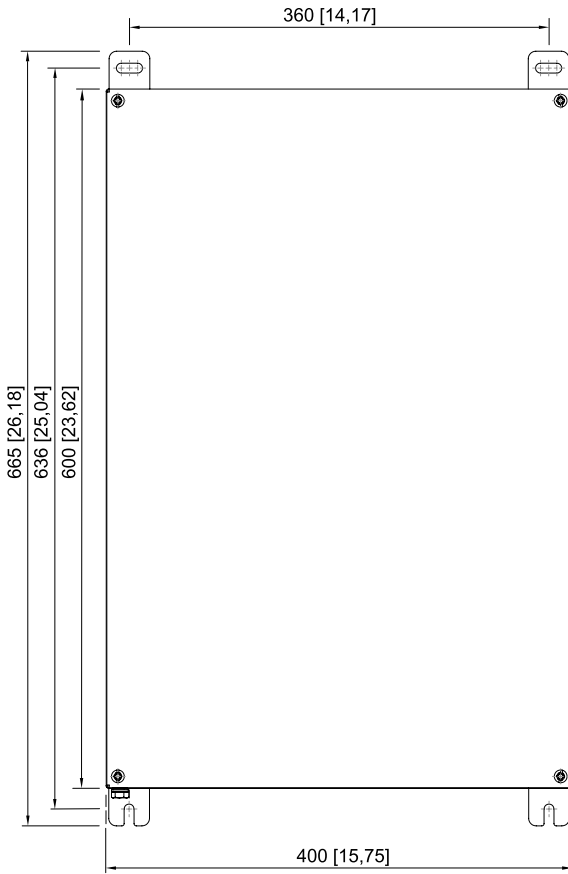
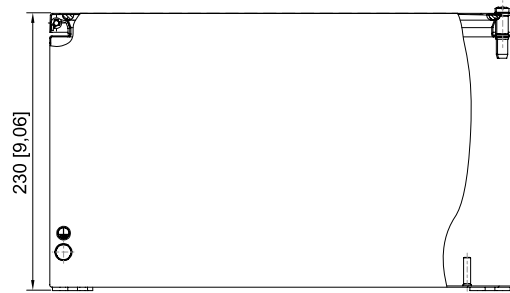
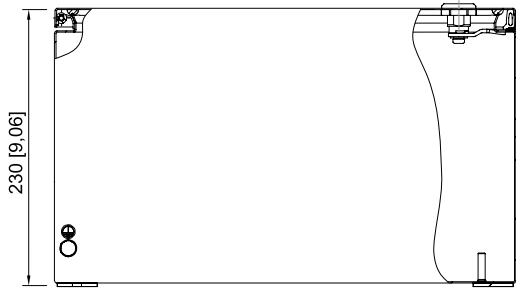

8151/0-116A-3321

8151/0-116A-3331

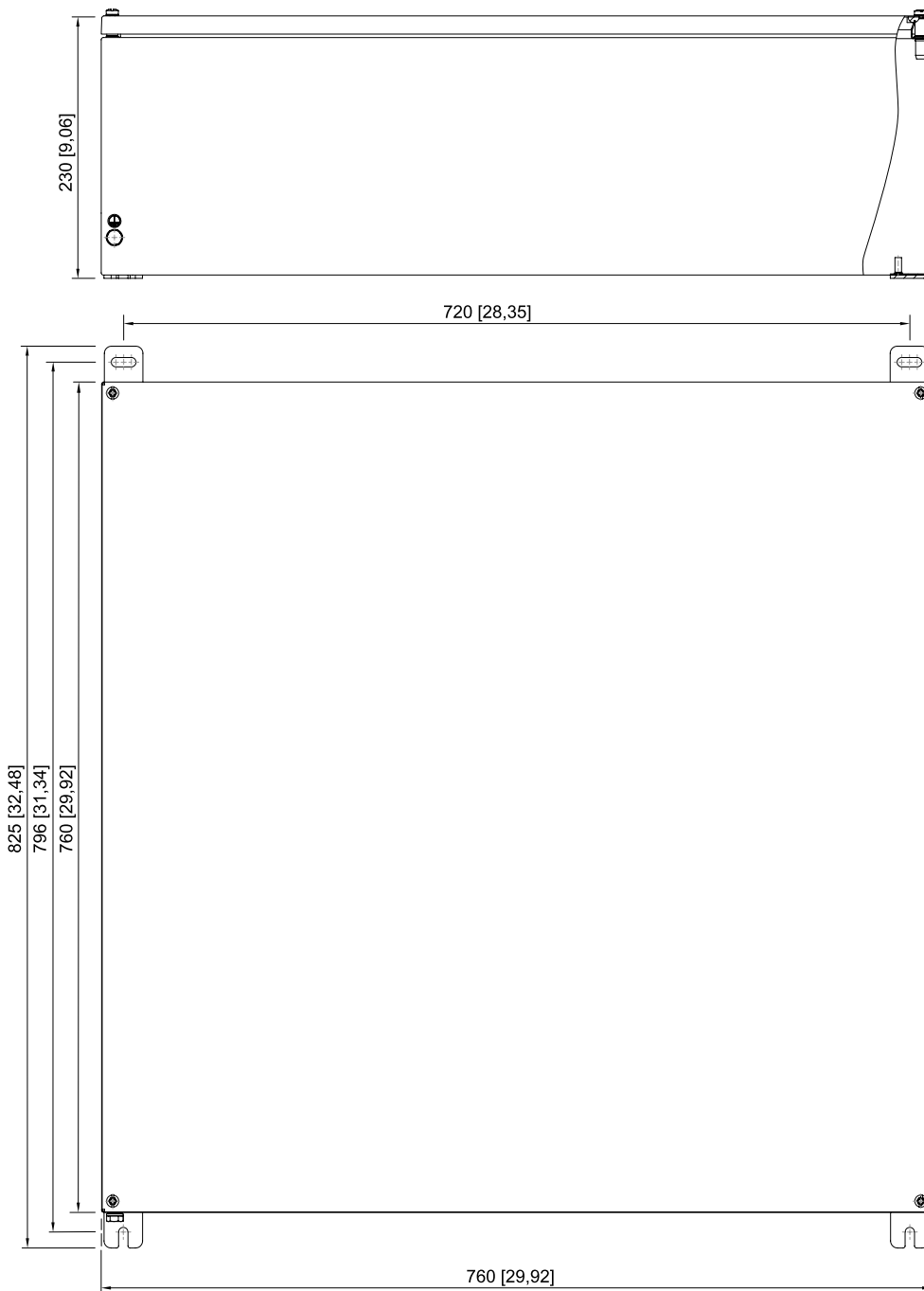

8151/0-126A-3311

E9

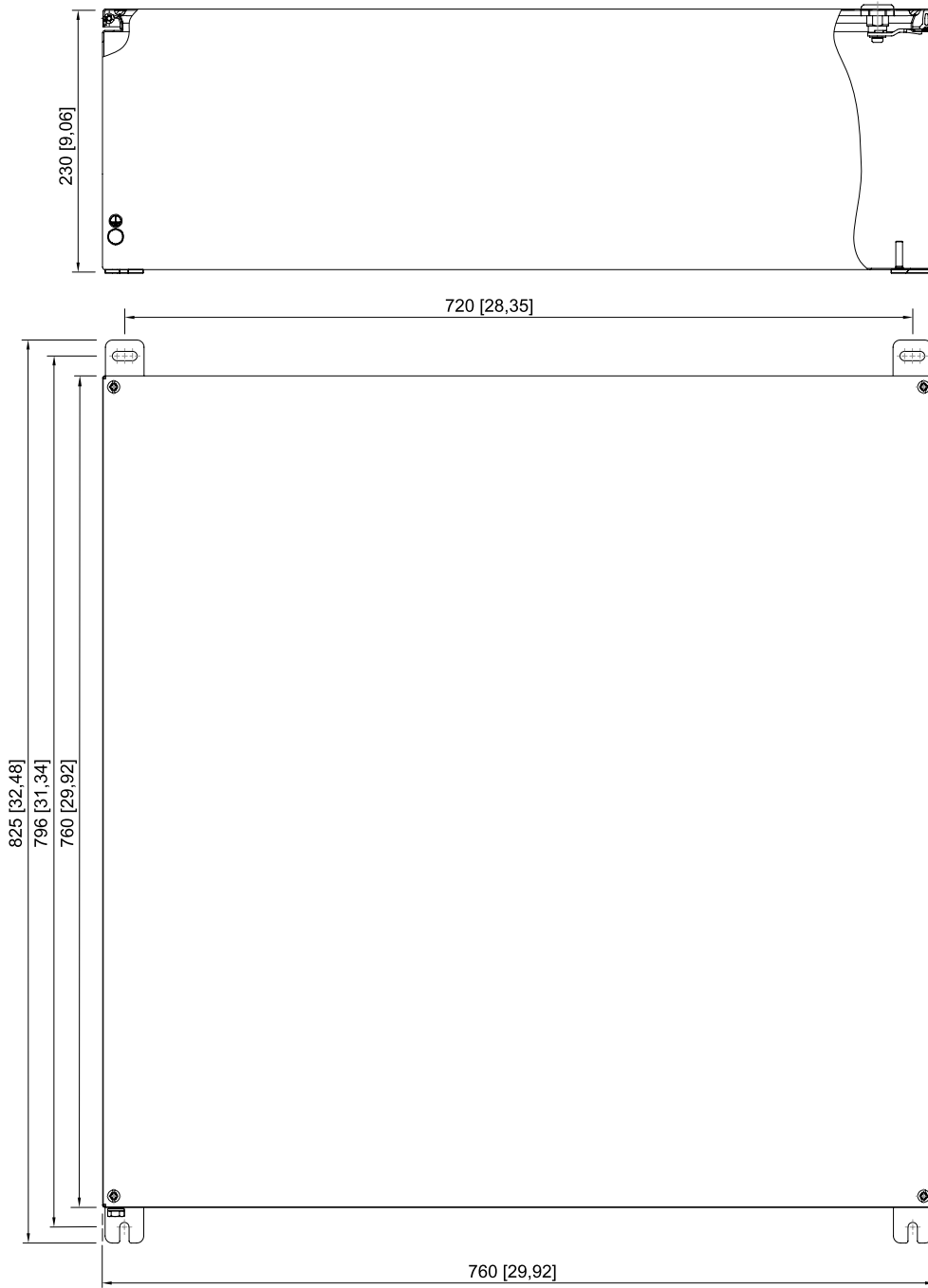

8151/0-126A-3321

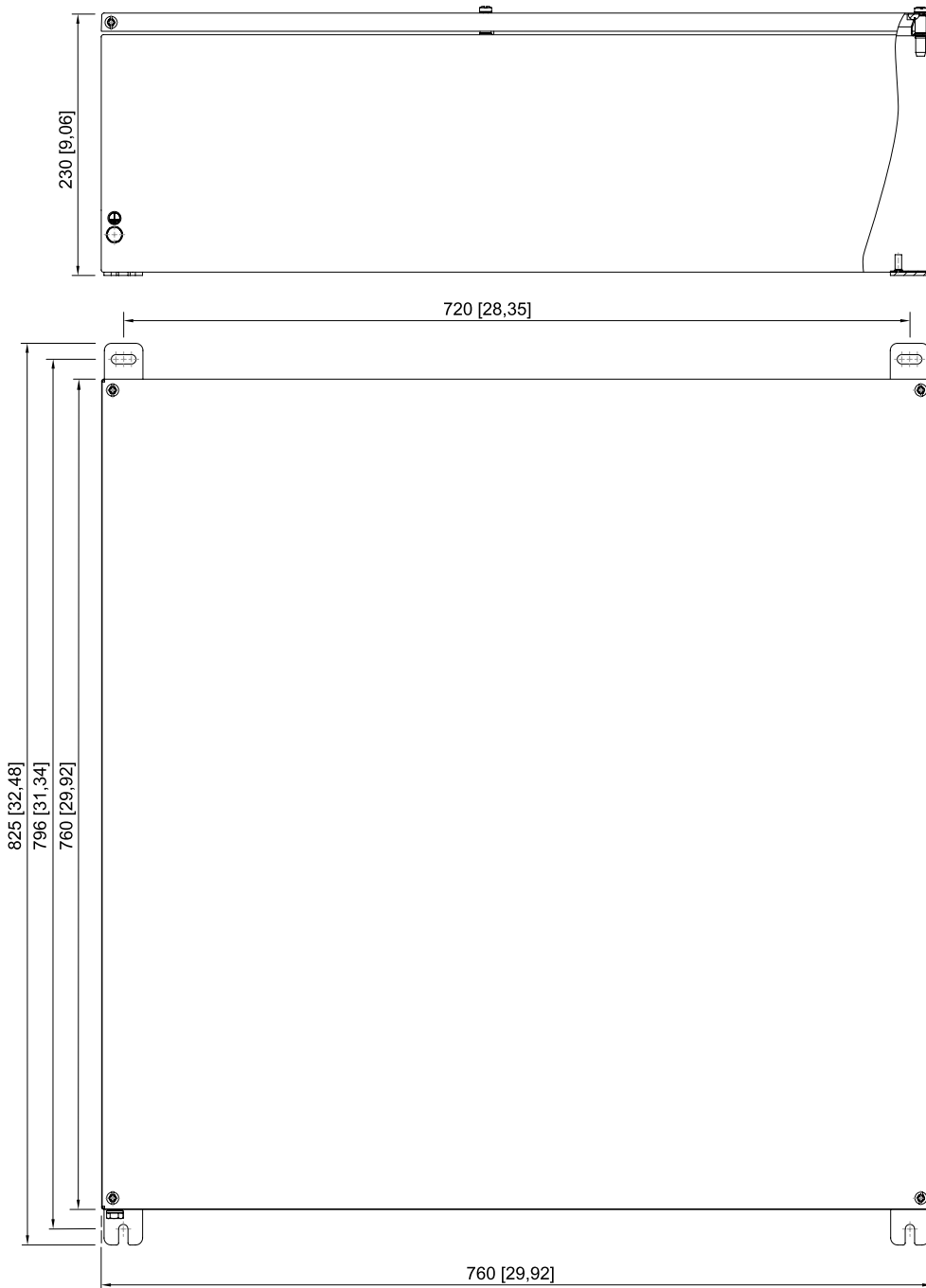

8151/0-126A-3331

E9

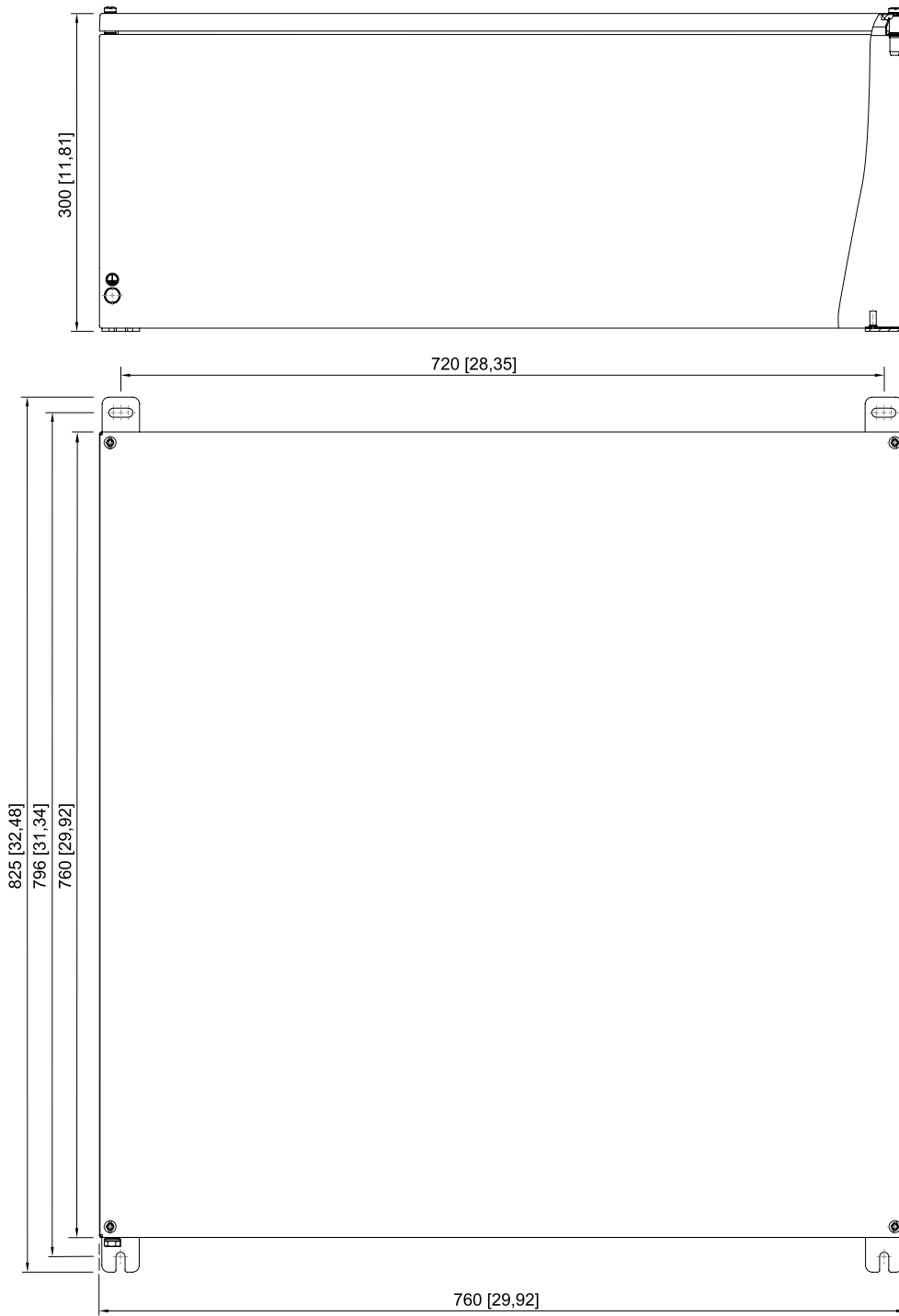

8151/0-128A-3311

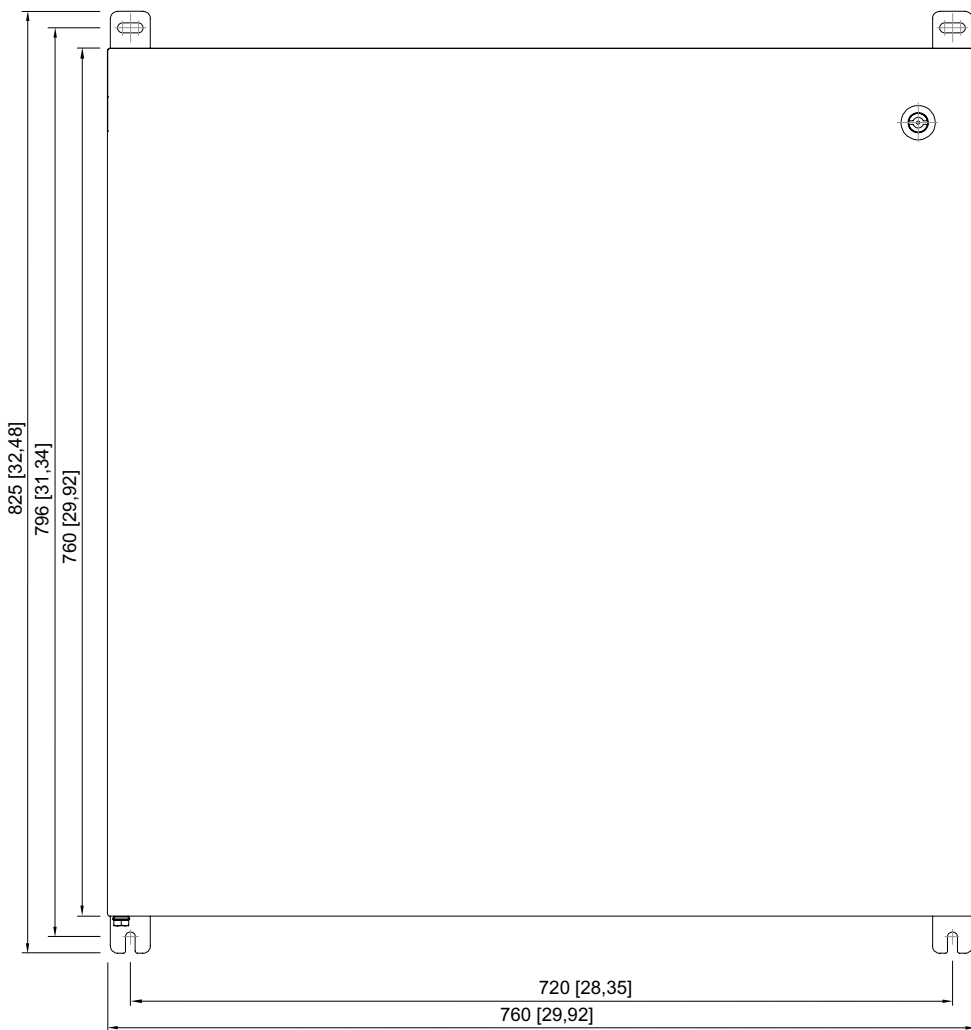
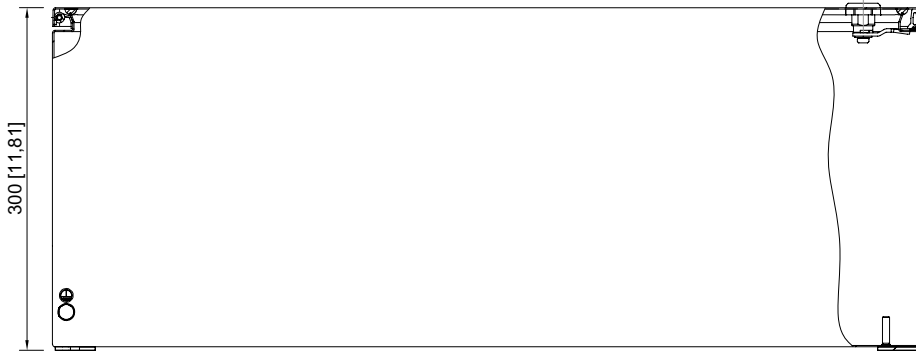

8151/0-128A-3321

E9

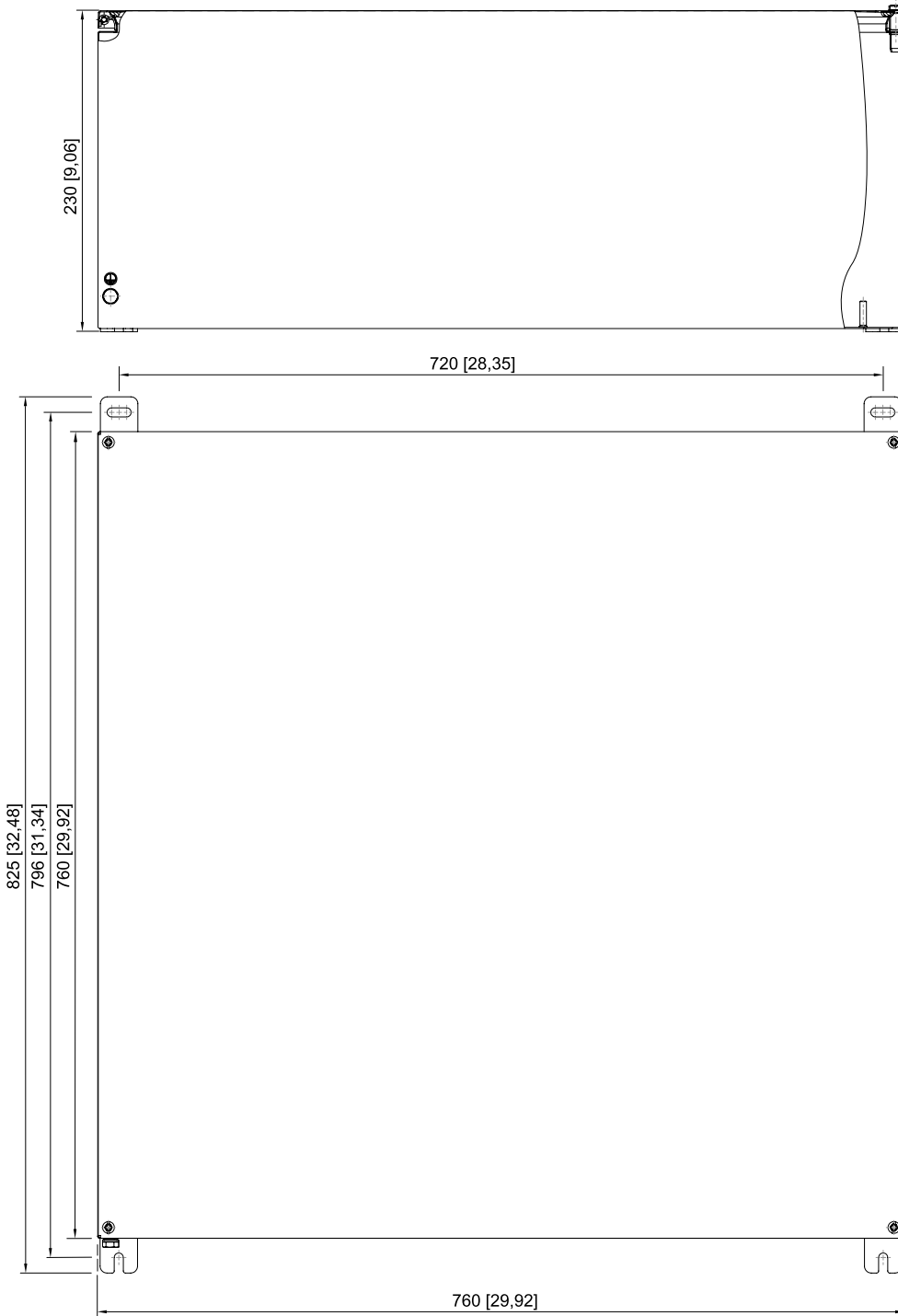

8151/0-128A-3331