



- Reliable load disconnect switch with easily visible, lockable handle and display of the switch position
- An integrated auxiliary contact for control and signalling purposes, can be optionally enhanced using pluggable Ex e or Ex i auxiliary contacts that are easily retrofittable
- Large temperature range of use
- High mechanical impact and shock resistance
- Perfect protection against penetration of liquids and dusts
- 3D data for download on the website

## MY R. STAHL 8581A



The R. STAHL Series 8581/31 sockets for Zone 1/21 in 4- and 5-pole versions have full AC-3 switching capacity up to 125 A. The high degree of protection (IP66) ensures maximum protection against the ingress of dust and water in any application situation. Self-cleaning lamellar contacts provide optimum contact and the plugs can be inserted and removed in the zero position quickly and easily. The load disconnect switch, with a mechanical locking device and a handle that can be locked in the 0 or I position, is an additional safety feature.

	IECEX / ATEX					
Zone	0	1	2	20	21	22
Installation in		•	•		•	•







Selection Table								
Product description	125 A wall-mounting socket							
Auxiliary contacts	2 (1 NO + 1 NC)							
Figure	Detailed number of poles	Coding (clock hour position)	Rated operational voltage AC	Colour code	Frequency range	Product Type	Art. No.	Weight
	3 P + N + PE	6	200/346 ... 240/415 V AC	Red	50 / 60 Hz	8581/31-506	277857	20.5 kg
		7	277/480 ... 288/500 V AC	Black	50 / 60 Hz	8581/31-507	277858	20.5 kg
	3 P + PE	6	380 ... 415 V AC	Red	50 / 60 Hz	8581/31-406	277859	19.2 kg
		7	480 ... 500 V AC	Black	50 / 60 Hz	8581/31-407	277860	19.2 kg
		9	200 ... 250 V AC	Blue	50 / 60 Hz	8581/31-409	277861	19.2 kg

Technical Data	
Explosion Protection	
Area of application	European Union (ATEX) IECEX China (CQST)
Area of application Note	Other country markings available on request
IECEX gas explosion protection	Ex db eb IIC T6 ... T5 Gb
IECEX dust explosion protection	Ex tb IIIC T65 °C / T85 °C Db
ATEX gas explosion protection	Ⓔ II 2 G Ex db eb IIC T6 ... T5 Gb
ATEX dust explosion protection	Ⓔ II 2 D Ex tb IIIC T65 °C / T85 °C Db
Certificates	ATEX (PTB), Brazil (ULB), China (CQST), IECEX (PTB), Korea (KGS), Taiwan (ITRI)

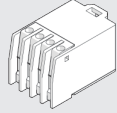
Technical Data	
Explosion Protection	
Declaration of conformity	ATEX (EGK), China (CCC)
Electrical Data	
Rated operational current	max. 125 A
Switching capacity main contacts	AC-3: 690 V, 125 A
Device Specific Data	
Back-up fuse with thermal protection	160 A gG
Back-up fuse without thermal protection	125 A gG
Ambient Conditions	
Ambient temperature	-45 °C to +60 °C
Mechanical Data	
Degree of protection IP (IEC 60529)	IP66
IP degree of protection (IEC 60079)	IP66
Enclosure material	Polyester, Glass fibre reinforced
Silicone-free	No
Multiple conductor connection	2 x 35 mm <sup>2</sup> to 2 x 50 mm <sup>2</sup>
Finely stranded connection cross-section	1 x 50 mm <sup>2</sup> ... 1 x 150 mm <sup>2</sup>
Stranded connection cross-section	1 x 35 mm <sup>2</sup> ... 1 x 150 mm <sup>2</sup>
Impact strength (IEC 60079)	7 J
Impact strength (IEC 62262)	IK10
Lockable in	in 0- and I-position
Components	
Cable entry note	Entry 1: Bottom left Entry 2: Bottom right
Entry 1 model	8161/7-M63-4828-LT
Entry 1 type	Polyamide cable gland
Entry 1	M63 x 1.5
Entry 1 clamping range	28 – 48 mm
Metal entry possible 1	No
Entry 2 model	8290/3-M63
Entry 2 type	Polyamide stopping plug
Entry 2	M63 x 1.5
Metal entry possible 2	No
Entry 3 model	8290/3-M25
Entry 3 type	Polyamide stopping plug
Entry 3	M25
Metal entry possible 3	No
Notes	Cable gland position: Bottom (standard); optionally also on the top or side

Ambient conditions					
Operating temperature range	Assignment of temperature class / ambient temperature / rated operational current / rated connection cross section				
	Tempertaure class		Rated operational current	Rated connection cross-section	
	T6	T5		Socket	Plug
		≤ +45 °C	125 A	≥ 70 mm <sup>2</sup>	≥ 50 mm <sup>2</sup>
	≤ +40 °C	≤ +55 °C	110 A		
	≤ +45 °C	≤ +60 °C	100 A		
		≤ +40 °C	125 A	50 ... 70 mm <sup>2</sup>	35 mm <sup>2</sup> Only heat-resistant conductors ≥ 85 °C e.g. use the NSSHÖU type!
	≤ +45 °C	115 A			
≤ +40 °C	≤ +55 °C	100 A	50 ... 70 mm <sup>2</sup>	35 mm <sup>2</sup>	

## Accessories

Figure	Description	Art. No.	Weight
<b>Auxiliary contact</b>			
	2 NC (8080/1-3) 250 V AC/DC Max. 6 A 1.5 to 2.5 mm <sup>2</sup> , solid/finely stranded The switching function of the auxiliary contact depends on the installation slot used. Left and right: Synchronising	168356	26 g
	1 NC + 1 NO (8080/1-1) 250 V AC/DC Max. 6 A 1.5 to 2.5 mm <sup>2</sup> , solid/finely stranded The switching function of the auxiliary contact depends on the installation slot used. Left: Delayed (ON), leading (OFF) Right: Synchronising	168351	26 g
	2 NO (8080/1-4) 250 V AC/DC Max. 6 A 1.5 to 2.5 mm <sup>2</sup> , solid/finely stranded The switching function of the auxiliary contact depends on the installation slot used. Left and right: Synchronising	168353	26 g
<b>Plastic cable gland</b>			
	8161/7-M25-1707, Ex e Plastic, M25 x 1.5, cable outer diameter 7 to 17 mm Lot size 50 pieces	239157	19 g
<b>Plug</b>			
	8581/12-406 4-pole plug, 380 to 415 V AC, 50/60 Hz, 125 A	277864	1.27 kg
	8581/12-506 5-pole plug, 200/346 to 240/415 V AC, 50/60 Hz, 125 A	277862	1.37 kg
	8581/12-409 4-pole plug, 200 to 250 V AC, 50/60 Hz, 125 A	277866	1.27 kg
	8581/12-407 4-pole plug, 480 to 500 V AC, 50/60 Hz, 125 A	277865	1.27 kg
	8581/12-507 5-pole plug, 277/480 to 288/500 V AC, 50/60 Hz, 125 A	277863	1.37 kg
<b>Stopping plug</b>			
	8290/3-M25 Plastic, M25 x 1.5 Lot size 1 piece	143524	10 g

## Spare Parts

Figure	Description	Art. No.	Weight
<b>Auxiliary contact key</b>			
	For removing installed auxiliary contacts	201909	35 g

Spare Parts

Figure	Description	Art. No.	Weight
Repair set for Series 8581 sockets			
	Repair set 8581 hinged cover, black	275511	220 g
	Repair set 8581 hinged cover, blue	275503	220 g
	Repair set 8581 hinged cover, red	275510	220 g

Dimensional Drawings (All Dimensions in mm [inches]) – Subject to Alterations

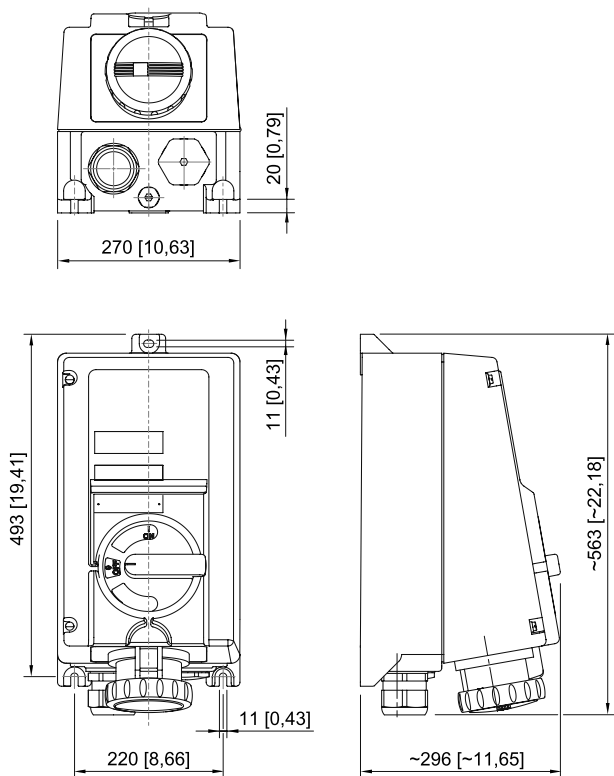

Wall-mounting socket