

# INSTALLATION & OPERATION MANUAL



# IT400

## Remote Totalizer & Rate Indicator

Document # MN-IT400-R2c.doc



# Notice

## Proprietary Notice

The information contained in this publication is derived in part from proprietary data and trade secrets. This information has been prepared for the expressed purpose of assisting operating and maintenance personnel in the efficient use of the instrument described herein. Publication of this information does not convey any rights to use or reproduce it or to use for any purpose other than in connection with the installation, operation and maintenance of the equipment described herein.

Copyright 2008

Printed in the USA. All Rights Reserved.

# SAFETY INSTRUCTIONS

The following instructions must be observed.

- Every effort has been made to design and manufacture this instrument to be safe for its intended use. A hazardous situation may occur if this instrument is not used for its intended purpose or is used incorrectly. Please note operating instructions provided in this manual.
- The instrument must be installed, operated and maintained by personnel who have been properly trained. Personnel must read and understand this manual prior to installation and operation of the instrument.
- An auto-resettable fuse internally protects this instrument. To reset the fuse, remove all power from the unit for one minute.
- The manufacturer assumes no liability for damage caused by incorrect use of the instrument or for modifications or changes made to the instrument.

## Technical Improvements

Liquid Controls Sponsler, Inc. may modify the technical data herein without notice.

**Warning:** Do not open the enclosure when an explosive gas atmosphere is present.

# Table of Contents

Description .....	1
CE Declaration of Conformity .....	1
Specifications .....	2
Wiring and Hookup Diagrams .....	3
IT400 Operational Overview .....	7
Calibration .....	7
Temperature Compensation .....	7
Linearization .....	7
LCD Display .....	8
User Controls .....	9
Non-User interfaces .....	9
Inputs.....	11
Backlight.....	12
Power .....	12
Enclosure .....	13
Menu System .....	14
Button functions.....	14
Editing numbers .....	14
Menu descriptions .....	15
Appendix.....	23
Appendix 1: Menu Quick Reference.....	24
Appendix 2: Coefficient of Thermal Expansion for Common Fluids.....	25
Appendix 3: Menu Flow Chart .....	26
Appendix 4: Manual Revision History .....	33

# Description

## General Unit Operation

The **IT400** Remote Totalizer and Rate Indicator is a microcontroller based flow instrument capable of translating flow information and conditions to the built-in display and various outputs.

## Features

- Pulse input supports turbine as well as many other pulse-type flowmeters
- All features/configuration settings are available via field programmability
- Independent rate/total display
- Magnetically operated internal switches maintain enclosure integrity
- Built-in digital multimeter and simulation functions for testing
- 2-20 point Linearization available
- Non-resettable "Grand" totalizer
- All outputs are fully opto-isolated (not RS-232)
- RS-232 port available
- Temperature compensation (RTD probe) available
- Backlight and backlight timer for low light display viewing
- Autoranging Rate display (decimal point will shift based on the size of the rate)
- Selectable power modes for customized battery life
- Available Datalogger can capture up to seven process/system values

## CE Declaration of Conformity

This is to certify that the listed equipment below conforms to the listed Directive and Product Standard.

Name of Manufacturer: Liquid Controls Sponsler, Inc. A Unit of IDEX Corporation  
2363 Sandifer Boulevard  
Westminster, SC 29693 USA

Type of Equipment: Flow Totalizer  
Conforming Models: IT400-DC-TRCL-AWX-RFARS2D (and derivatives)  
Directive/Product Standard: EMC Directive 89/336/EEC using EN61326  
Equipment Type/Environment: Normal Locations

Sponsler Company, Inc.  
Date: March 18, 2008

Signature: Burt Anderson  
Title: VP Operations



## Specifications

### ➤ Display

- Total
  - 8 digit 5.40mm high LCD (continuous display)
    - Batch total (magnetic reset)
    - Grand total (no reset)
- Rate
  - 5 digit 8.66mm high LCD (continuous display)
  - Range over/under limit indication
  - Refresh rate: Multiple depending on power mode (1/16s, 1/8s, 1/4s, 1s, 0.5s)
- Backlighted green w/ LED (magnetically activated and timed)
- Dual segment low-battery warning
- Maintenance due warning
- Temperature range warning

### ➤ Power:

- Internal: D Lithium battery
  - Battery life: Various: typical per power mode: 1: 1yr, 2: 1yr; 3: 3.6yr; 4: 3yr; 5: 8yr
- External DC: 5 to 48VDC +/- 2 VDC reverse polarity protected (Max: 12mA w/ backlight)
- Loop: requires 7VDC of loop supply
  - Loop powered from the 4-20mA loop input (non-isolated)

### ➤ K-Factor range

- Pulses per gallon: 0.0000001 to 999999

### ➤ Signal Input (flow)

- Frequency: 0-3000Hz
- Impedance: 10k ohms
- Magnetic
  - Sensitivity: 50mV-36V (field adjustable) sine or square wave
- Modulated carrier
  - Carrier frequency 50kHz (requires external power or loop power)

### ➤ Compensation Input

- Temperature - RTD
  - Two wire 10k ohm
  - Coefficient of Thermal Expansion method
- Frequency
  - Linearization table 2 to 20 points

### ➤ Engineering Unit Conversions

- Pre-programmed units: Gallons, Liters, Ft<sup>3</sup>, M<sup>3</sup>, Pounds, BBL, KG (custom weight available)
  - Custom units available with given units/gallon
- Rate and Total may have separate unit displays

### ➤ Decimal Locations

- Total: Two places (and x10, x100)
- Rate: Three places (and x10, x100), autorange

### Time Base

- Rates can be displayed in units per second, minute, hour, day, and custom (in seconds)

### Outputs

- Factored Pulse (Max: 150mA, 30VDC, 150mW)
  - Opto-isolated open collector output
  - Frequency or fixed pulse width (1, 2, 5, 10, 50, 100, & custom ms) output setting
  - Output pulse Divider: 1, 2, 5, 10, 50, 100, 1000, & custom
- Alarm (Max: 150mA, 30VDC, 150mW)
  - Programmable opto-isolated open collector output
  - Can be used to control totalization (Max values at 25°C. Max combined Pulse/Alarm output power: 190mW @ 25°C, 32mW @ 65°C)
- Rate (4-20mA)
  - Factored rate to current loop output
  - Programmable low and high
  - Fully isolated (unless loop powered)
  - Loop Voltage limit: 7-36VDC

### ➤ Accuracy

- Display: ±0.01% reading (rate) or ± 1 count (total)
- Analog output: ±0.025% of fs @20°C
- Digital output: ±1 count

### ➤ Environmental

- Operating: -30 to 65°C (-22 to 150°F)
- Storage: -40 to 85°C (-40 to 185°F)

### ➤ Enclosure

- Explosion Proof Aluminum
  - FM Approved, CSA Certified
  - Class I, Division 1, Groups B, C, & D
  - Class II, Division 1, Groups E, F, & G
  - NEMA 4X, IP66
  - All openings ¾" FNPT
  - Weight: 2.5lbs.
  - Mount: Directly on flowmeter or Wall mount

### ➤ Compliance

- CE 0575
- ATEX Ex II 2 G Ex d IIC T6 Gb (X and WX enclosure types only)
- DNV-2008-OSL-ATEX-19241X

### ➤ Communications

- RS-232

### ➤ Datalogger

- Up to four triggers (including timer)
- Up to seven system values
- Real-time clock
- RS-232 or Internal SD/MMC Flash media card

### ➤ Other features

- EEPROM setup storage (>100 year retention)
- All features/settings are field programmable. Convenient number input via 0-9 rotary switch and two pushbuttons

# Wiring and Hookup Diagrams

The **IT400** has many connections all made through the bottom/mounting board. It is recommended to remove the battery when connecting wires to the connectors and when plugging the connectors into their sockets.

## Wiring

In order to maintain the rated CE marking, the following practices must be followed:

- All wires connected to the **IT400** must be shielded (exception: SI supplied signal cable).
  - All shields must be connected to one of the internal mounting screws to achieve their ground connection.
  - It is recommended that the non-**IT400** end of these shields is left unconnected. This will help avoid ground loops and unexpected behavior.
  - It is recommended that only one spade type terminal be used on each of the screws. Care should be taken to avoid shorting any spade with other circuitry on the mounting board. If a longer screw is needed to attach the shielding spade, then the screw must be chosen to ensure at least one extra thread of space behind the screw. The hole depth is approximately 0.250 inches.
  - Shields should not cover more than one pair of signal wires at a time.
- The **IT400**'s chassis must be connected to an earth ground via the screw attached to the outside of the unit. At least a 12 AWG preferably green wire is recommended.
- All connections are to be made to the unit via rigid conduit.
- All connected wires must not exceed 98' length.
- DC powered devices requiring the CE marking must be 4-20mA loop powered.

If no wires are required for a particular installation; the only requirement is the chassis ground connection.

## Battery Removal and Installation

Battery Replacement: The internal battery may only be replaced with one of two batteries:

- E8010 from Liquid Controls Sponsler, Inc.
- TL-5930/F from Tadiran Batteries, Ltd.

Battery Removal: Unscrew the **IT400** cover, press and hold the menu button until the option to reset the totalizer appears, the totalizer/grand totalizer/service timer will be saved to memory. Using two fingers inserted in the slots on the top and bottom of the main board overlay, gently rock the board top to bottom while pulling straight out. If this is done too quickly or unevenly, the main board will be damaged. After the main board is removed, the battery is accessible by opening the hook-loop strap. Once the battery is loose, the battery clip is removed by compressing the locking tab on the connector (locking tab is on the top of the connector {J3}) and pulling it out.

Battery installation: Reverse the process for installation. Ensure the battery connector key is in the proper orientation prior to insertion.

Diagrams:

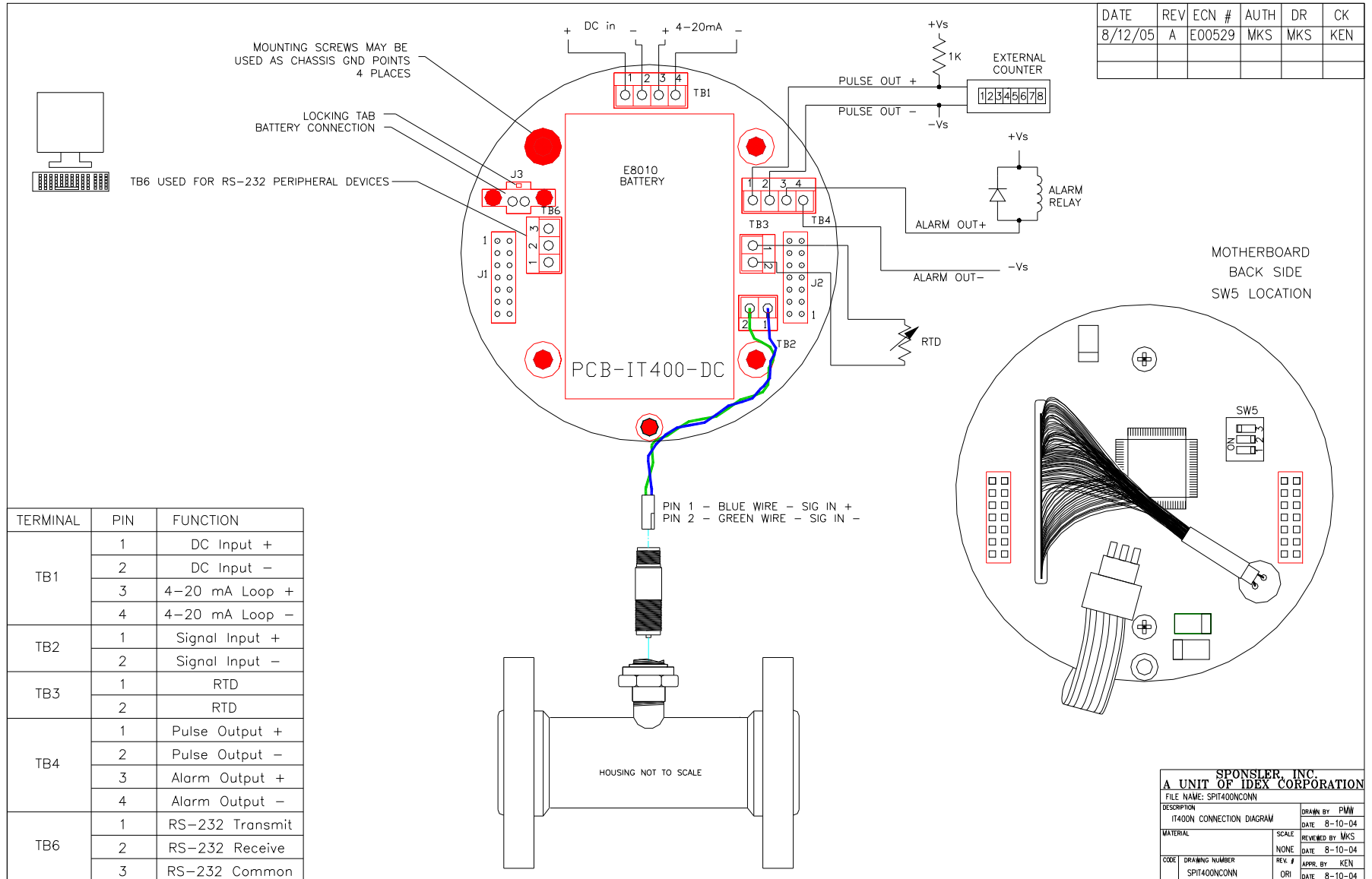
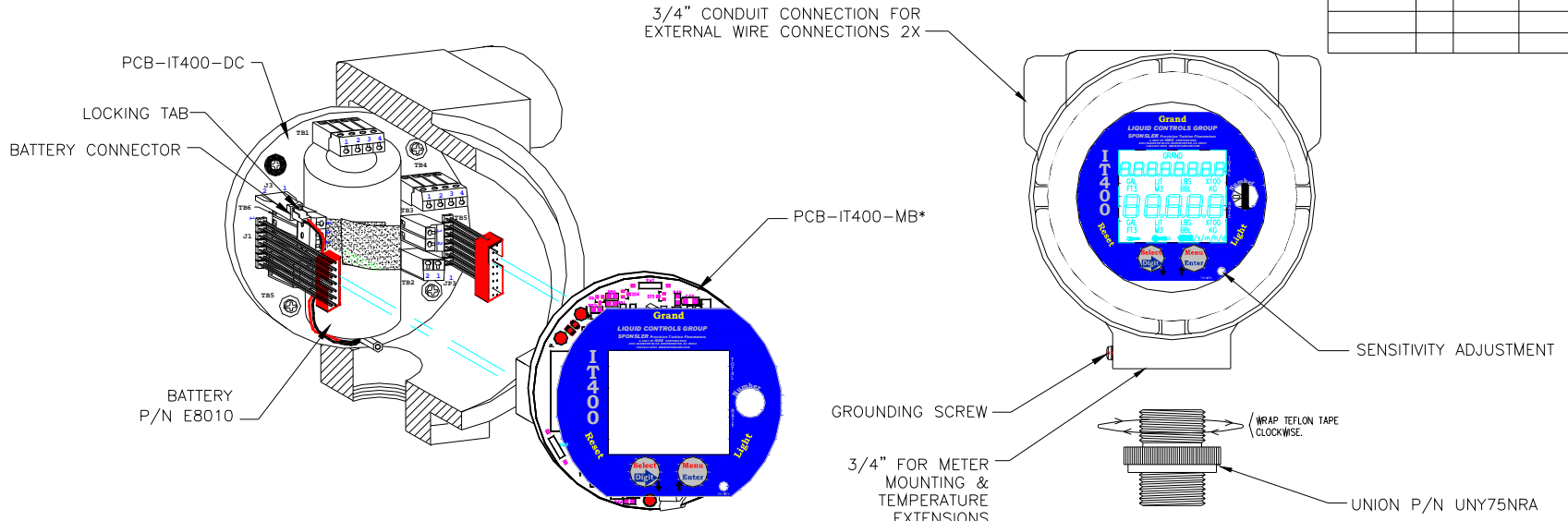

Figure 1 IT400 Connections



DATE	REV	ECN #	AUTH	DR	CK
3/6/2008	A	E00794	MKS	MKS	KEN



INSTALL MOUNTING BOARD IN 4 HOLES IN THE BOTTOM OF THE ENCLOSURE USING THE HARDWARE ILLUSTRATED BELOW.

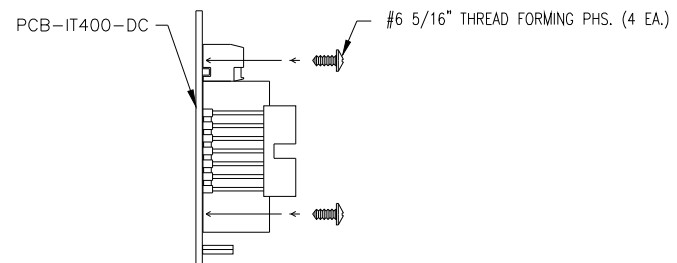

NOTE: PCB-IT400-DC MAY BE ROTATED WITHIN THE ENCLOSURE TO ANY OF 0°, 90°, 180°, OR 270° POSITIONS.

NOTE: TO REMOVE THE MAIN BOARD, FIRST REMOVE THE IT400 COVER. USING TWO FINGERS INSERTED IN THE SLOTS ON THE TOP AND BOTTOM OF THE MAIN BOARD OVERLAY, GENTLY ROCK THE BOARD TOP TO BOTTOM WHILE PULLING UPWARD. IF THIS IS DONE TOO QUICKLY OR UNEVENLY, THE MAIN BOARD WILL BE DAMAGED.

TOLERANCES (EXCEPT WHERE NOTED)		SPONSLER, INC. A UNIT OF IDEX CORPORATION	
DECIMAL	+ .XX .015 + .XXX .005	FILE NAME: MECHANICAL\ELECTRONICS\IT400\IT400ASSY.DWG	
FRACTIONAL	+ 1/64"	DESCRIPTION: IT400 ASSEMBLY	DRAWN BY: PMW
ANGULAR	+ 1/2°	MATERIAL:	DATE: 3/6/2008
FINISH	63	SCALE: NONE	REVIEWED BY: MKS
UNLESS OTHERWISE SPECIFIED		CODE: IT400ASSY	DATE: 3/6/2008
		DRAWING NUMBER: IT400ASSY	REV. #: A
		APPR. BY: KEN	DATE: 3/6/2008

Figure 2 IT400 Board Stack Assembly and Battery Removal



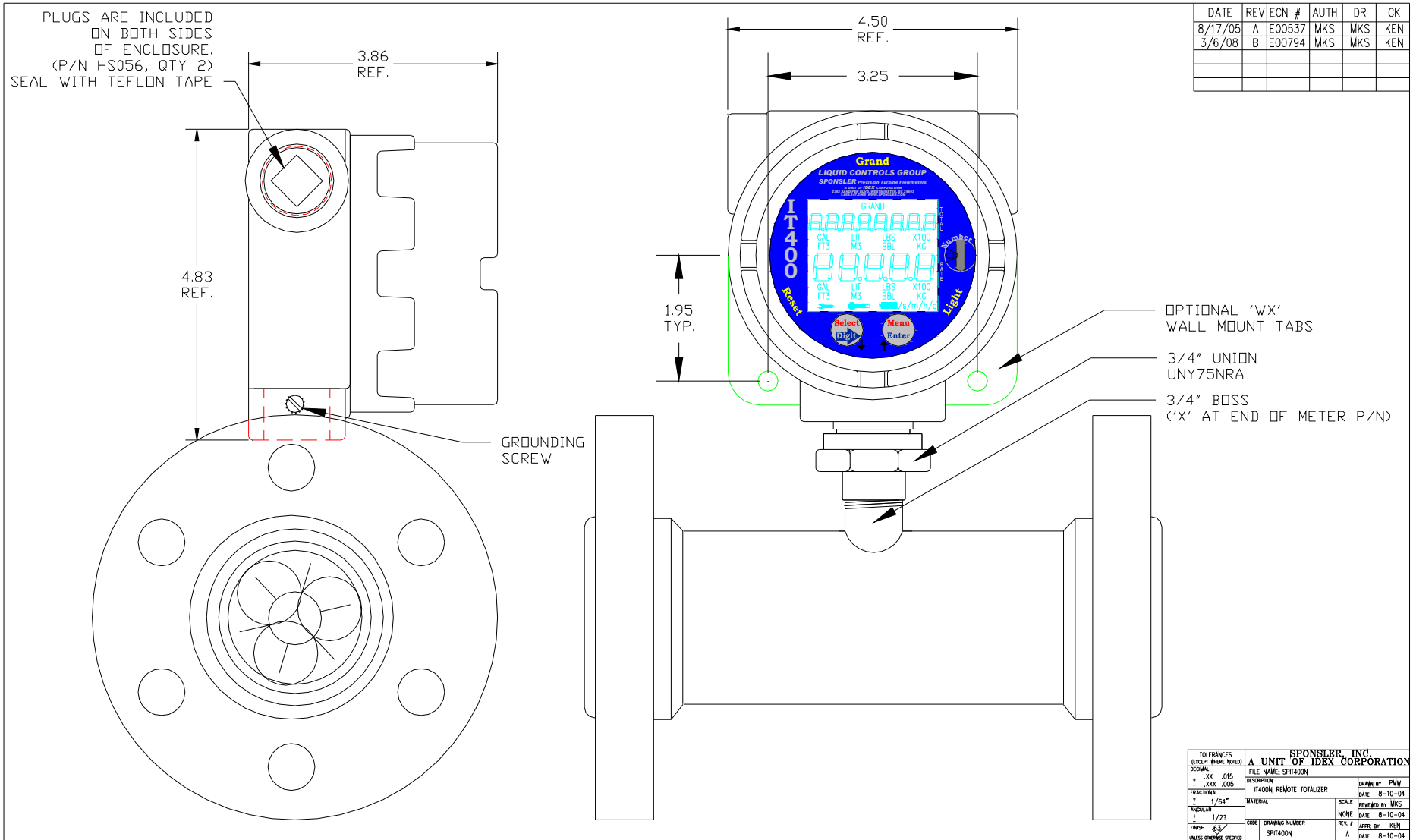

Figure 3 Meter Mounting and Dimensional

# IT400 Operational Overview

The **IT400** flowmeter system will perform the necessary calculations to provide the user with an optional temperature compensated and optional linearized output of the following values:

- Rate
- Total
- Grand total
- Errors/warnings
- Various outputs

## Calibration

Calibration of the **IT400** is accomplished using either a linear K-Factor (pulses per gallon) or a linearized K-Factor linearization table (when the linearizer is enabled). Independent unit conversion factors and decimal points are available for the rate and total displays. Calibration and configuration data are stored in an onboard EEPROM for permanent storage. Calibration of the IT400's reference circuitry is factory set and is not user accessible. Calibration of the IT400's reference circuitry should be performed by factory trained service personnel.

## Temperature Compensation

The temperature compensator utilizes a platinum RTD to detect the process temperature. Process temperature is used in conjunction with the reference temperature and Coefficient of Thermal Expansion of the measured liquid (menu items) to adjust the rate and total values. When the temperature compensation is enabled, the temperature warning annunciator (thermometer on the LCD) will indicate when the process temperature is out of a programmable range. Optionally, an alarm output as well as a totalizer inhibit function can also be tied to this temperature warning. Various Coefficient of Thermal Expansions and their reference temperatures can be found in the appendix. The temperature circuit and associated algorithm, when enabled, increase the **IT400** current consumption from the power source and diminish battery life if running solely from the battery. A programmable delay function has been provided in order to minimize the impact of the temperature sampling on the battery life. The delay feature specifies the number of seconds between temperature value samples. The higher the delay, the longer the battery will last.

## Linearization

The linearizer utilizes a linear interpolation algorithm to calculate the rate and total based on a set of calibration data points programmed by the user. The linearizer has 21 points, the first point (lowest) is automatically set at zero hertz, the remaining 2 to 20 are user programmable. The linearizer table must have at least two data points in addition to the first (fixed) point and must be ascending in frequency from the first point to the last. To have fewer than 20 points in the linearizer table, after the last desired linearization point add one additional point and set the frequency at zero. Zero is an invalid frequency; this will indicate the end of the table. The **IT400** will not allow frequencies to be entered out numerical order. Frequencies between zero and the first programmed point will use the K-Factor of the first programmed point.

## LCD Display

The LCD display has three main areas: The 8 digit totalizer, 5 digit rate indicator, and the annunciators.

- The 8-digit totalizer shows the total number of units of volume through put of the flowmeter since the last time the totalizer was reset. The totalizer is resettable by 2 methods, via a magnetic reed switch in the lower left side of the unit and by menu. The grand total is displayed as long as a magnet is placed near the top of the face of the unit. The word "GRAND" indicates the displayed value is the grand total. Grand should be activated prior to battery replacement to save total/grand total values to non-volatile memory. Engineering unit annunciators display the units and decimal place selected to compute total and grand total values. The grand totalizer uses the same engineering unit as programmed for the totalizer.
- The 5-digit rate display shows the rate of the flowmeter throughput. If the rate exceeds the high flow warning setpoint, "-OL-" is displayed. "-LL-" is displayed when the rate is less than the low flow warning setpoint. The warning is displayed until flowrate within these setpoints resumes. The totalizer is not affected by this warning unless programmed to inhibit totalizer when out of range. The range limits are established by the flow warning setpoints (Warning menu) in the menu system. Indicators on the display also show the engineering units of volume, time and decimal place used to compute the rate value.

**Note:** When the Grand Total magnetic reed switch is activated (and **GRAND** is displayed on the screen), the rate display will display the current rate regardless of the range limits. This is helpful when troubleshooting flow condition problems when the low rate setpoint is set above zero.

- Refresh rate of the display of the unit happens at pre-determined intervals depending on the selected power mode (see "Power"). Once the power mode is programmed (in the menu), the refresh rate is fixed. This prevents a low refresh rate from being automatically selected which could cause measurement delay.
- Other display annunciators. These are warning indicators and do not inhibit the operation of the unit (unless explicitly enabled to do so by the alarm option). These indicators may however indicate the condition causing an inaccurate reporting of rate or total information.
  - Wrench – The service annunciator is user programmable to a specific amount of "turbine hours" (active flowmeter hours).
  - Thermometer – The thermometer annunciator is displayed continuously any time the temperature compensator is enabled and the process temperature is out of range.
  - Battery – The battery annunciator is composed of two segments. The segments indicate the level of the battery charge, like an automotive gas gauge.
    - Two segments – The battery is within normal operating voltage range.
    - One segment – A replacement battery should be acquired and installed. This will also cause high temperature range on the temperature circuit to be reduced.

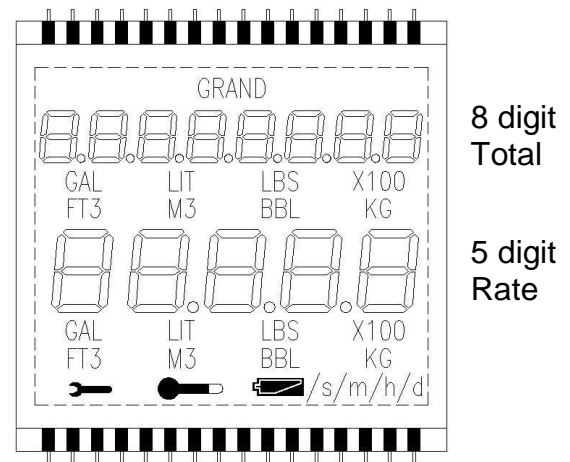

- No segments – The battery must be replaced to guarantee accurate reporting.

## User Controls

There are two main groups of user controls, internal and external. The internal controls are only accessible when the enclosure cover is removed. The external controls are magnetically accessed by strategic placement of a magnet along the outside of the unit.

- Internal
  - **Menu / Enter** Button – This button is used primarily within the menu system. Press this button at any time during **RUN mode** to enter the menu system. **Note:** the higher the power mode, the longer the button will need to be held down for it to trigger the menu system.
  - **Select / Digit** Button – This button is also used primarily within the menu system. However, when the temperature compensation option is purchased and enabled, pressing this button while in **RUN mode** causes the 5-digit display to indicate the current process temperature in degrees Fahrenheit.
  - **Number** Dial – The **number** dial is only used while selecting values or editing numbers while in the menu system. The **number** dial is disabled in **RUN mode**.
- External
  - Magnetic Switches – There are three magnetically activated reed switches located around the edge of the **IT400** (indicated on the front panel with yellow text). These switches allow external activation of the following functions:
    - Grand** – The following actions are taken when the grand reed switch is activated:
      - The total display will indicate the value of the grand totalizer.
      - The rate display will indicate the current rate regardless of any out of range warning conditions.
      - The **GRAND** annunciator will indicate.
      - The **IT400** will store the values of the grand totalizer, the totalizer, and the elapsed service time to non-volatile memory. This is useful if the **IT400** is to be removed from service (replace battery, recalibrate, etc).
    - Light** – When activated, the backlight timer will be engaged according to the chart in the Backlight section.
    - Reset** – When activated, the main totalizer will be reset.

**Note:** The internal user controls are described in more detail in the **Menu** section.

## Non-User interfaces

Non-user interfaces are those that are wired to external devices. 4-20mA rate output and open collector pulse output are standard, open collector alarm output, RS-232, datalogger, and real time clock interfaces are optional.

- **4-20mA rate output** is a linear representation of flow rate between the programmed low and high setpoints.
  - Example:** A flowmeter has a calibrated range of 10 to 100gpm, the desired low and high setpoints of the 4-20mA output are 10 and 100 respectively. Using these values, the **IT400** will calculate and output the proper current reading for a given flowrate.

Given a flow rate of 25gpm, the current loop reading will be 6.667mA. The output engineering units are the same as for the rate display.

**Note:** For loop powered operation, refer to the **Power** section.

**Note:** The **IT400** requires 7VDC of the loop supply.

- **Pulse output** is an open collector design. A pull up resistor is required for interface with most systems. An output pulse occurs with each increment of the totalizer if a pulse output divider of 1 has been programmed. For programmed pulse divider values other than 1 the output pulse will occur at the divided value. Functions for a frequency output, pulse width, and pulse output divider are programmable. When the frequency output is not selected, pulses are output in bursts at each refresh.

**Example:** The totalizer increments 15 pulses (over the last refresh time) and the pulse output divider is 5. The number of output pulses that will be generated will be 3.

**Note:** If the output pulse width programmed exceeds the time required to output the proper number of output pulses an E will be displayed in the left-most character of the total display. The **IT400** will output as many pulses as time permits at the programmed pulse width.

**Example:** At a maximum flow of 900gpm the proper number of output pulses is 15 per second, but the pulse width is programmed to 100ms and the pulse divider to 1. The 15 pulses would take 1.5 seconds (15x100ms); only 10 pulses would be outputted. Either the pulse width must be reduced or if acceptable the divider increased.

**Guideline:** calculate the maximum output pulse width:

Maximum pulse width = 1/(output pulses per second/output pulse divider)

Using the example above: 1/(15/1) = 66.6ms is maximum pulse width.

- **Alarm output** is an open collector output that can be used to externally indicate the presence of several out of range conditions. These conditions include: temperature, flow rate, and battery level. The ranges of temperature and flow rate are edited in their respective sections of the **Menu** system. The Battery low level is factory set. Any Alarm condition of the enabled alarms will activate the alarm output. Identical to the output pulse, a pull up resistor is required to interface with most systems.
- **RS-232 interface** allows calculated values of the unit to be viewed upon request. To use this interface, a serial device (computer or datalogger) is used to poll the **IT400** by sending one of the listed letters (the letter by itself) to the serial port. No carriage return is necessary. The **IT400** will reply with the requested data and a CR+LF. The BAUD rate is fixed at 9600 baud 8N1. Currently, the datalogger data can only be captured via the RS-232 port. The functions available on this interface are:

R – Rate	Z – Reset Totalizer	K – K Factor
T – Total	Q – Total CF	L – Linearizer Table
G – Grand total	W – Rate CF	F – Process Temperature (Deg F)
C – Capture Data (Trigger a datalogger event)		

**Note:** Using the RS-232 interface when loop powered will cause errors in the loop reading.

- **Datalogger** allows various working data to be captured based on several different triggers. To use this interface, a serial input device (computer or printer) is used to capture the data from the **IT400**. Refer to the menu section of the manual to see the data that can be captured and what triggers are available. Each line of data is terminated by a CR+LF combination (0x0D and 0x0A). There are two data format outputs available, DB and non-DB:

**DB Format:** The DB format lists the enabled data in the following order: Time, Total, Rate, Grand Total, Temperature, K-Factor, and Warnings. Units are the same as displayed on the LCD. The time listed is the "UNIX" time or the number of seconds from the UNIX Epoch time (Jan 1, 1970, 0:00:00 GMT). No Daylight Savings Time (DST) or time zone adjustment is made. Example:

```
2147498935, 1073, 919.532, 37211, 32.2, 58.71818, 0
2147498937, 1104, 919.687, 37242, 32.2, 58.71818, 0
2147498939, 1135, 919.506, 37273, 32.2, 58.71818, 0
2147498941, 1165, 919.557, 37303, 32.2, 58.71818, 0
2147498943, 1196, 919.609, 37334, 32.2, 58.71818, 0
2147498945, 1227, 919.385, 37365, 32.0, 58.72917, 0
```

**Non-DB Format:** The non-DB format lists the enabled data in the same order as in the DB format, but will be listed one item per line. In addition, this format shows the engineering units of each value. The date/time is adjusted for local time zone as set in the menu. DST is not included as this would allow duplicate time stamps. Example:

```
Date/Time: Mon Jan 18 2038 13:14:54 GMT-5:00:00
Total: 98 G
Grand Total: 36235 G
Temperature: 32.0F
K-Factor: 58.72917 P/G
Warnings: 0:
```

- **Real-time clock** maintains the current date and time for use with the datalogger. Each datalog event is preceded with the current date and time. Time is calculated by maintaining the number of seconds since the UNIX Epoch time (Jan 1, 1970, 0:00:00 GMT). The real-time clock does not increment unless the **IT400** is powered (either by DC-in, battery, or 4-20mA). When the battery is replaced, the internal clock will be slow by the amount of time between the time the menu is entered (just prior to removing the battery) and the time the **IT400** is again powered (after the battery replacement). The real-time clock can be set in the menu system and is only available when the datalogger option is purchased.

## Inputs

The **IT400** has four inputs: RS-232 interface, user interface, temperature, and input signal.

- **RS-232** interface is described above.
- **User** interface is described above.
- **Temperature** input is a standard 2-wire platinum RTD temperature probe (0.385 TCR). The temperature probe is typically mounted within a few inches downstream of the attached flowmeter. The temperature input will increase the drain rate on the battery when the **IT400** is battery powered. The temperature input is ignored if the temperature compensator is disabled.

- **Signal** input from practically any frequency generating device producing a sinusoidal signal, a square wave pulse or can be connected to a modulated carrier pickup coil.
    - Sinusoidal signal:** low amplitude crossing signal that doesn't exceed the **IT400's** input specification. This signal can come directly from the pickup coil sensing rotation of the attached Sponsler, Inc. turbine flowmeter or other flowmeter device.
    - Square signal:** any zero referenced pulse that doesn't exceed the **IT400's** input specification.
    - Modulated carrier:** derived by modulating a carrier signal of the pickup coil caused by the change in impedance resulting from the rotor blades passing in proximity to the coil. This is an inductive coil therefore there is no drag on the rotor. MC coil operation is factory enabled only. MC coil operation requires DC or loop power.
- Note:** SW5-3 must be "On" for MC coil operation when externally DC powered.

## Backlight

The backlight is controlled by a combination of system parameters. The following table lists the operation of the backlight and how it is controlled by these various system parameters:

DC Powered	4-20mA Powered*	Battery Condition	blLkE value	Backlight in -rUn-	Backlight in Menu
Yes	Don't Care	Don't Care	Non-Zero	ON	ON
No	No	Good	Non-Zero	Timer	ON
No	No	Low	Don't Care	Manual	OFF
No	Yes**	Good	Non-Zero	Timer	ON
No	Yes	Don't Care	Don't Care	Manual	OFF
Don't Care	Don't Care	Don't Care	dI5AbLEd	Manual	OFF
Don't Care	No	Good	ALlAY5on	ON	ON

\* SW5-1, SW5-2, & SW5-3 "On".

\*\* SW5-3 "Off" (4-20mA loop to power modulated input and battery to power main circuit).

\*\*\* If the timer is set to *ALlAY5on*, the battery will last about two months when not DC powered.

The front panel magnetic reed switch activates the backlight regardless of anything (as long as power is applied). Backlight activation may increment one additional input pulse and will cause 4-20mA errors.

## Power

The **IT400** may be powered externally by any 5-48VDC source, 4-20mA loop, internally by battery, or by a combination of these. Power consumption is affected by programmed options, input signal frequency, and the programmed power mode.

- **External Power**
  - **DC:** 5-48VDC
  - **4-20mA Loop:** used to power the **IT400** or just the modulated carrier circuit (which requires more voltage than is available from the battery). The **IT400** requires 7VDC of the loop supply.

- **Internal Battery** functions either as a primary power source or as a backup to either of the external power sources. Battery life estimates are in the Power Mode chart below and are affected by the options enabled. The battery may be replaced at any time with the only side effect being a loss of normal operation (all calibration and configuration information is maintained). Total, Grand Total, and service hours may be saved at any time by activating the **Grand Total** display or by entering the menu system. Upon system startup, the saved values will be retrieved.

External DC	Loop Isolation	Battery Powered	SW5-1	SW5-2	SW5-3	Main IT400 Power	Modulated Carrier Power
Yes	Yes*	No	Off	Off	On	External	External
No	No**	No	On	On	On	Loop	Loop
No	No**	Yes	On	On	Off	Battery	Loop

\*For External power, the loop isolation switches SW5-1, 2 must be “**Off**” (isolated).

\*\* Loop powered operation; the loop isolation switches SW5-1, 2 must be “**On**” (non-isolated).

- **Power Mode:** controls the refresh rate of both the display and outputs of the **IT400** and is a user selectable menu item. Refresh times and approximate battery life are in the following table:

Mode	Refresh	Input frequency	Approximate Battery (years)
1	16 refreshes/s	0	
		500	
2	8 refreshes/s	0	
		500	
3	4 refreshes/s	0	6.5
		500	3.2
4	1 refreshes/s	0	
		500	
5	2s/refresh	0	
		500	

\*Battery life calculations are worst case based on continuous flow, enabled linearizer, temperature compensator, 4-20mA output, and pulse output.

## Enclosure

The **IT400** is contained in an explosion proof enclosure. This enclosure is typically meter mounted via a union or a temperature extension (consult factory for lengths and applications). There is typically a short cable (4 feet) that connects the **IT400** to an external temperature probe (a few inches downstream). Rigid conduit is recommended for this connection to maintain the explosion proof rating of the enclosure and to maintain CE marking.

# Menu System

The **IT400**'s menu system is designed to allow a simple means of entering all of the data required for the system to perform its calculations. This section steps through the menu system and provides a description of each item. To enter the menu system, simply press **Menu**.

## Button functions

**Menu / Enter** – The menu button advances through the menu system. When editing values, this button provides the “enter” function. **Note:** The menu may be exited while viewing any main menu item by pressing and holding **Menu**, then pressing and holding **Select**, then releasing **Menu**, next releasing **Select**.

**Select / Digit** – The select button is used to change values and edit numbers. To edit a displayed number, **Select** is pressed to allow editing. When editing numbers, each press of **Digit** shifts right the digit to be edited. When selecting between two values, **Select** is used (this includes *YES/NO*, *ENABLEd/di SABLEd*, and *POS/nEG*)

**Number** – The number dial is used to set the current displayed item to a specific value. When editing numbers, the flashing number will change according to the number dial. When editing decimal placement of a number, the decimal point will change according to the number dial.

## Editing numbers

Some menu items require the editing of a number. All three controls are used to edit the number. Here is a short example of editing the low temperature warning set point:

- Number to be edited is displayed:
- Press **Select** to edit the number.
- If the number can be positive or negative, press **Select** to toggle between positive (*POS*) and negative (*nEG*).
- Press **Enter** to accept the desired sign.
- Next, the actual number can be edited. Numbers are edited from left to right. The digit that is currently being edited will flash. Use the **Number** dial to change the flashing number to the desired value. If no change is needed, do not move the **Number** dial.
- Press **Digit** to move the edit focus to the next digit. Repeat these steps as necessary to edit all the digits in the number.
- Press **Enter** to accept the changes to the number.
- If the number can have a decimal, the current decimal location will flash. Use the **Number** dial to change the flashing decimal to the desired location. If no change is needed, do not move the **Number** dial.
- Press **Enter** to accept the decimal location.
- In most cases, an opportunity to re-edit the number is presented.

-350.0000  
bīPLo

POS  
bīPLo

nEG  
bīPLo

350.00000  
bīPLo

## Menu descriptions

The menu is composed of a list of editable items which control the operation of the **IT400**. This is a listing of all of the menu items. The **IT400** reverts to the **Run Mode** if no user input is detected within 30 seconds while viewing any of the following top level menu items.

### 1. Reset Totalizer

Resets the totalizer without using an external magnet. If the totalizer reset is set to **no**, the subsequent submenu is not displayed.

```
rst no
total
```

#### 1.1 Reset Totalizer Done

This is an informational message that indicates that the main totalizer has been reset.

```
rst done
total
```

### 2. Temperature Compensation Enable

Displayed only if purchased as an option. Temperature compensation can be enabled or disabled. If compensation is **disabled**, the next two sub-menus are skipped.

```
Enabled
temp
```

#### 2.1 Reference Temperature

Temperature at which the Coefficient of Thermal Expansion is referenced. The temperature units are degrees Fahrenheit and must match the Coefficient of Thermal Expansion used in the next item (and is listed in the Appendix).

```
°F 60.000
ref t
```

#### 2.2 Coefficient of Thermal Expansion

The Coefficient of Thermal Expansion for select fluids can be found in the Appendix.

```
0.000 10 15
temp
```

### 3. Linear Interpolation Enable

Displayed only if purchased as an option. Linear interpolation can be enabled or disabled. If linearization is **disabled**, the next three sub-menus are skipped.

```
Enabled
Linear
```

#### 3.1 Linear Interpolation Table Edit

Permits the editing of the linearizer table and is only set if the linearizer has been enabled. If set to **no**, the linearizer table will not be edited and the menu system jumps to menu 4 (**K-Factor**) below. If the table is to be edited, the menu will step through the list of points in the order of frequency then K factor. The frequency values must be ascending starting with the first point being the lowest.

**Note:** To enter a table of fewer than 20 points in the linearizer table, after the last desired linearization point add one additional point and set the frequency to zero. Example: For 15 point linearization, set the frequency for point 16 to zero.

**Note:** The table must have at least two points.

```
Edit no
table
```

### 3.2 Frequency Input

Permits setting of the frequency of a given run in the linearizer. The number listed on the display indicates which point in the table is being edited. Frequencies must be in ascending order (point 1 is the lowest frequency). When the frequency is set, press **Enter** to accept.

**Note:** If a frequency point is entered that is not ascending, the device will restore the original value and return to the frequency for that point.



10.000000  
Fy 01

### 3.3 K-Factor Input

Allows the setting of the K-Factor of a given point in the linearizer. The number listed on the display indicates which point in the table is being edited. When the K-Factor is set, press **Enter** to accept.

**Note:** If the table was edited, upon accepting the last K-Factor, the menu will return to menu 3.1 Linear Interpolation Table Edit.

**Note:** The table edit may be exited while viewing any K-Factor by pressing and holding **Menu**, then pressing and holding **Select**, then releasing **Menu**, then releasing **Select**.



5.0000000  
FAC01

## 4. K-Factor

Only available if the linearizer is *diSAbLEd*. The K-Factor is the non-linearized base meter factor and is always in pulses per gallon. Both total and rate displays use this K-factor in their base conversion.



60.000000  
FcTOr

## 5. Totalizer Units

Set by turning the **Number** dial to the desired position. The dial positions allow several standard conversions as well as three customizable settings. The conversion (from gallons) of each position is listed in the upper display. The customizable settings are LBS, KG, and {blank}. For each of these engineering units, the system allows a customized "per gallon" conversion to be entered. The {blank} item is for engineering units that are not included in the standard list. **Example:** To display pounds of liquid nitrogen, **LBS** (#2) is selected with the dial and the value is edited to read 6.745 (6.745 pounds of LN2 per gallon).



1.0000000  
Uni t t

## 6. Totalizer Decimal Place

Set by turning the **Number** dial to the desired position. If no decimal is shown, the decimal is assumed one place to the right of the least significant digit.

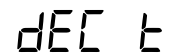

dEC t

## 7. Ratemeter Units

Set by turning the **Number** dial to the desired position. The dial positions allow several standard conversions as well as three customizable settings. The conversion (from gallons) of each position is listed in the upper display. The customizable settings are LBS, KG, and {blank}. For each of these engineering units, the system allows a customized "per gallon" conversion to be entered. The {blank} item is for engineering units that are not included in the standard list. **Example:** To display pounds of liquid nitrogen, **LBS** (#2) is selected with the number dial and the number is edited to read 6.745 (6.745 pounds of LN2 per gallon).



1.0000000  
Uni t r

## 8. Ratemeter Decimal Place

Set by turning the **Number** dial to the desired position. If no decimal is shown, the decimal is assumed one place to the right of the least significant digit. There is one special setting named *AUTORANGE*. The autorange setting allows the ratemeter display to self adjust the decimal point based on the size of the number to be displayed. **Example:** Ratemeter decimal set to *AUTORANGE*. If the rate is 12.873 GPM, then *12.873* will be displayed. If the rate increases to 128.73 GPM, then *128.73* will be displayed.

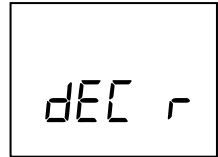

## 9. Rate Time Base

The time the ratemeter is based on in seconds. The **Number** dial positions allow several standard time bases as well as one customizable setting. The conversion (in seconds) of each position is listed in the upper display. The customizable setting is indicated by the absence of any time annunciator at the bottom of the display. The {blank} item is for units that are not included in the standard list. **Example:** To display the rate in units per week, the customized number would be edited to read *604800.00* and no annunciator is displayed.

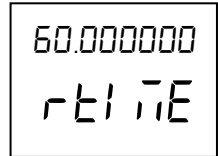

## 10. 4-20mA Output

The 4-20mA analog output is enabled or disabled in this menu. If the 4-20mA output is *dI SAblEd*, the next two sub-menu items are skipped.

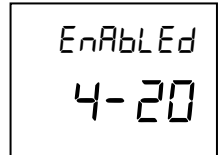

### 10.1 4-20mA Output Low Setting

Used by the 4-20mA output as the low setpoint. Edit the number to read the desired low flowrate setting. The setpoint engineering units are the same as the ratemeter engineering units.

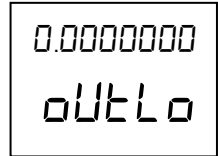

### 10.2 4-20mA Output High Setting

Used by the 4-20mA output as the high setpoint. Edit the number to read the desired high flowrate setting. The setpoint engineering units are the same as the ratemeter engineering units.

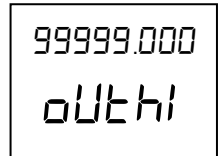

## 11. Pulse Output Enable

The pulse output is enabled or disabled in this menu. If the pulse output is disabled, the next two sub-menu items are skipped.

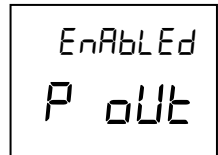

### 11.1 Pulse Output - Pulse Width

The pulse width of the pulse output is set by turning the **Number** dial to the desired position. The dial positions allow several standard pulse widths as well as one customizable setting. The selected pulse width in milliseconds is listed in the upper display. There is one special setting named *FREQUENCY*. The frequency setting allows the pulse output to auto adjust the pulse width based on the number of pulses to be outputted per second. **Example:** Pulse width set to *FREQUENCY*. If the totalizer is counting to 14 every second, then the output pulse width will be 71.428ms. If the totalizer is now counting to 55 every second, then the output pulse width will auto

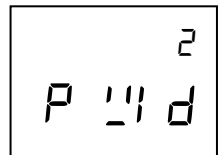

adjust to 18.2ms. The *FREQUENCY* setting is especially useful when using the pulse output as a ratemeter, however, if a ratemeter output is desired, the 4-20mA loop will provide better results. Dial position #7 provides a customized pulse output setting initially set to 75, which can be edited for any pulse width (max 999ms).

**Note:** If the pulse width exceeds the inverse of the number of requested output pulses per second, the total display will indicate this error with an *E* in the left most totalizer character during **Run Mode**. When the *E* is displayed, output pulses are being lost. **Example:** If the pulse width is set to 500(ms), then the maximum number of pulses that may be outputted is two per second.

### 11.2 Pulse Output - Pulse Divider

Divides the pulse output by the displayed value. The divider is set by turning the **Number** dial to the desired position. The dial positions allow several standard pulse dividers as well as one customizable setting. The selected pulse divider is listed in the upper display. The customized pulse divider setting is switch position #8 (initially set to 75), and can be edited for any value (max 9999).

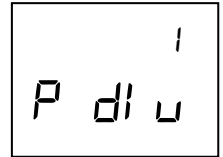

## 12. Backlight Timer

Determines the length of time the backlight remains "On" when activated. Set by turning the **Number** dial to the desired position. The dial positions allow several standard timer values in seconds as well as one customizable setting. The selected timer value is listed in seconds in the upper display. If the timer is set to *ALWAYS ON*, the battery will last about two months. This setting is not needed for DC powered units as the backlight is always on when DC powered anyway. The customized backlight timer setting is switch position #9 (initially set to 75), and can be edited for any number of seconds (max 9999s).

**Note:** The backlight timer is only a timer. Even when disabled, the backlight may be used when a magnet is located by the **Light** magnetic reed switch.

**Note:** The backlight is the highest current drawing component of the **IT400**. Use it sparingly; excessive use will quickly reduce the battery life (when running on the internal battery).



## 13. Power Mode

Sets the **IT400**'s internal power savings functions and the refresh rate. The power mode is set by turning the **Number** dial to the desired position. Power modes range from mode 1 (fastest refresh, shortest battery life) to mode 5 (slowest refresh, longest battery life). The power mode is described in greater detail in the Power section of this manual.

**Note:** When power mode is set to 5, the datalogger activation timer period (*Act. Tir*) will be rounded down to the nearest even number.



## 14. Alarm

Displayed only if purchased as an option. The alarm menu allows the setting of various system warnings to trigger an alarm. The number at the top of the display indicates which alarms are enabled: A 1 indicates the associated alarm is enabled, and a 0 indicates disabled. Starting from the left side of the screen, the alarms are in order in the following list:

1. *LbAtt* – Low battery. Enables the low battery warning (absence of any battery annunciator when running off battery) to trigger the alarm.
2. *tEiPU* – Temperature under. Enables a low process temperature warning to trigger the alarm.
3. *tEiPo* – Temperature over. Enables a high process temperature warning to trigger the alarm.
4. *rAtEU* – Rate under. Enables a low flow rate warning to trigger the alarm.
5. *rAtEO* – Rate over. Enables a high flow rate warning to trigger the alarm.
6. *noTot* – No totalize during alarm. Inhibits the totalizer whenever there is an alarm condition. Using this setting prevents special “out of range” flow conditions from affecting the totalizer.

**Example:** The temperature set points are set for the liquid state range of LN2, and the *noTot* is set to *EnAbLEd*. The totalizer will not count any “gassing” of the meter (it will not totalize when the detected temperature is outside the liquid temperature range).

To set an alarm, press **Select**. A prompt to enable the Low battery alarm is presented. Press **Select** again to toggle between *EnAbLEd*, and *diSAbLEd*. When the selection is set, press **Enter** to accept and move to the next alarm. Continue through all alarm settings. When the last alarm is set, the original list of all alarms is presented.

123456

000000

ALArT

## 15. Service Hours

Displays the number of hours remaining until the service hours have elapsed. If the service hours setpoint is to be programmed or to reset the service hours counter, press **Select**. Press **Menu** to skip the next two sub-menu items.

999

SErVE

### 15.1 Service Hours Set Point

Displays the number of hours the flowmeter sees a rate other than zero before the wrench annunciator is displayed. When this number is edited (press **Select**), the Service Hours counter is automatically reset to zero elapsed hours (proceed to the next sub-menu item). To exit without resetting the Service Hours counter, press **Menu** (skip the next sub-menu item).

1000

CUrnt

### 15.2 Service Hours Set Point Edit/Reset

When the Service Hours setpoint Edit/Reset menu is entered, the Service Hours counter is automatically reset to zero. The Service Hours setpoint may be set to any number of hours less than 99999 hours.

0 1000

5 SEt

## 16. Datalogger

123456



Displayed only if purchased as an option. The datalogger menu allows the setting of various data outputs and when to capture. Every datalog event is preceded by the date and time of the capture (See the Real Time Clock section). The number at the top of the display indicates which data are enabled: A 1 indicates the associated data is enabled, and a 0 indicates disabled. Starting from the left side of the screen, the data are in order in the following list:

1. **WARnG** – Warning. Enables any warnings to be included in the log.
2. **K-Factor** – K-Factor. Enables the K-Factor value to be included in the log. This will track the K-Factor (and will change only during linearizer and temperature compensation use).
3. **TEMP** – Temperature. Enables the temperature value to be included in the log.
4. **gTotL** – Grand Total. Enables the grand totalizer value to be included in the log.
5. **rATE** – Rate. Enables the rate value to be included in the log.
6. **totAL** – Total. Enables the totalizer value to be included in the log.

### 16.1 Setting Data to be Captured to the Datalogger

To set the data to be included in the log, press **Select**. A prompt to enable the warnings output is presented. Press **Select** again to toggle between *EnAbLEd*, and *diSAbLEd*. When the selection is set, press **Enter** to accept and move to the next data setting. Continue through all data settings as listed above. When the last data setting is set, the menu automatically proceeds to the Datalogger Activation and Output Settings.

### 16.2 Datalogger Activation and Output Settings

Setting the datalogger activation and output settings flows seamlessly from the previous menu listing. The same procedure as in the data settings above is used to enable and disable these settings. The list below describes the menu items in this section:

1. **RESEt** – Activate by **Reset**. Will activate a datalog event when the reset input is activated. The logged event will actually occur just prior to the reset action. Therefore, the data that is captured will be for the last total displayed. To get a datalog event that shows a total of zero, activate the reset function a second time.
2. **WARn** – Activate by Warning. Will activate a datalog event whenever there is a change in a warning. An event will be triggered when the warning is indicated, as well as another event when the warning changes (shows no warning or a secondary warning).
3. **gTnd** – Activate by **Grand**. Will activate a datalog event when the grand total is activated.
4. **rATE** – Activate by timer. Will activate a datalog event based on an internal timer. The period of the timer is set by **rATE** (below). If this option is disabled, the Activation timer period is not asked.
5. **SErdb** – Serial output in DB format. This is a toggle between the two output format types:
  - DB format Enabled** – Database format. This format will list the output data in a raw “listing” form. Each data value is listed as a comma separated list. The time/date that will be logged when this setting is enabled is based on GMT and will reflect the number of seconds that have passed since Jan 1, 1970 at 0:00:00 (including leap years, but not leap seconds, time zone, or DST). This is commonly referred to as “UNIX” time. This format is

useful when the data is captured to a computer and later imported into a data analysis program or database.

**DB format Disabled** – Pretty-Print format. This format will list data on separate lines, preceded by the name of the data and followed by the given units of measure. This format is more useful for ticket printing and human readability. The time/date that will be logged when this setting is enabled will be in the format: Fri Aug 12 2005 12:36:56 GMT-0400

- 6. **Rate Tr** – Activation timer period. Only available if **Rate Tr** is enabled. Sets the number of seconds between timer triggered datalog activations.

**Note:** If the power mode is set to 5, the activation timer period will be rounded down to the nearest even number.

## 17. Real-Time Clock

The real time clock menu allows the viewing and setting of the internal real time clock. Pressing **Select** toggles between the current date and time (the next two submenu items). Holding **Select** for more than 3 seconds allows editing.

HR:MN:SEC

12:36:56  
TIME

### 17.1 Current Time

Allows the setting of the time portion of the real time clock. The current time is set by holding **Select** for more than 3 seconds. Prompts for time zone (ZONE), hour (Hour), minute (min), and second (SEC) are displayed. The internal time will resume the instant **Enter** is pressed after entering seconds.

DY.MO.YEAR

15.08.2005  
DATE

### 17.2 Current Date

Allows the setting of the date portion of the real time clock. The current date is set by holding **Select** for more than 3 seconds. Prompts for year (YEAR), month (MONTH), and day (DAY) are displayed. Setting the date will not affect the time portion of the real time clock.

## 18. Warnings

The editing of the system warnings used for the on-screen warnings and the alarm set points (if purchased) is allowed when **YES** is selected here. Temperature limits and temperature delay are only available if temperature compensation is enabled or temperature is enabled in the alarm output, or the datalogger.

Edit no  
WARN

### 18.1 Edit Low Flow Limit

The minimum valid flow rate before triggering a low flow warning.

**Note:** In order to have the rate display show a low flow warning (-LL-) at zero flow, set this output low setting to 0.000 l.

0.0000000  
FLoLo

### 18.2 Edit High Flow Limit

The maximum valid flow rate before triggering a high flow warning.

9999999.2  
FLoHi

### 18.3 Edit Low Temperature Limit

The minimum valid temperature before triggering a low temperature warning.

-350.0000  
TEMPLo

### 18.4 Edit High Temperature Limit

The maximum valid temperature before triggering a high temperature warning.

**Note:** After setting a high limit, a display of *LOW LIMIT* indicates the low was not less than the high.



200.00000  
HIGH

### 18.5 Temperature delay

The number of seconds to wait between temperature measurements. The shorter the delay, the more accurately the temperature profile will represent the flow.

Shorter delay periods reduce battery life (when powered exclusively by battery). To edit the delay, turn the **Number** dial to select from one of the pre-programmed values, or select 75 (dial position 9) and edit the number for a custom delay. In **Run Mode**, the temperature annunciator will flash each time the temperature is sampled.



10  
DELAY

## 19. Test

The test menu allows the viewing, testing, and simulating of various system inputs and outputs. Here is a listing of the test items:



TEST

1. *RAW FREQ* – The displayed value is the raw input frequency (autoranged) being received by the flowmeter input. The value is in Hz. Pressing **Select** displays the max frequency received by the flowmeter input.
2. *RTD OHMS* – The displayed value is the raw resistance value of the RTD in ohms. The value is indeterminate if no RTD is installed.
3. *BATTERY / -dC IN / -LOAD-* – The displayed value is the battery voltage (if *BATTERY* is displayed) or internal voltage regulator if *-dC IN-* or *-LOAD-* is displayed.
4. *LCD TEST* – Pressing **Select** causes the **IT400**'s LCD to indicate all segments.
5. *4-20mA TEST* – Pressing **Select** causes the **IT400** to simulate five values on the 4-20mA output. The **Number** dial is used to step through the following values: 0%, 25%, 50%, 75%, & 100%. The backlight will be disabled during the 4-20mA output test so as to not affect the 4-20mA output. The dial must be turned until one of the values is displayed.
6. *VERSION* – The displayed value is the internal software version.

## 20. Menu Lockout Enable

Enables or disables the menu lockout. If the menu lockout is disabled, the menu is exited and **RUN mode** is resumed.



ENABLED  
LoC

### 20.1 Menu Lockout Code

Displays and allows the edit of the code that must be entered to gain access to the menu. A code of 0000 disables the lockout. Edit the number to read the desired lockout code setting. Only four digits are available for the lockout code. The default lockout code is 1000.



1000  
CODE

# Appendix

## Appendix 1: Menu Quick Reference

- |   |  |  |
|---|--|--|
| <p><b>1.</b> Reset Totalizer<br/>Done</p> <p><b>2.</b> Enable Temperature Compensation<br/>Reference Temperature*<br/><b>{60.0}</b><br/>Coefficient of Thermal Expansion* <b>{0.0001015}</b></p> <p><b>3.</b> Enable Linearizer<br/>Edit Linearizer Table<br/>Table Points*</p> <p><b>4.</b> K Factor (if Linearizer is disabled)* <b>{60.0}</b></p> <p><b>5.</b> Totalizer Units<br/>0) <b>Gallons</b><br/>1) Liters<br/>2) Pounds*<br/>3) Cubic Feet<br/>4) Cubic Meters<br/>5) Barrels<br/>6) Kilograms*<br/>7) Custom*</p> <p><b>6.</b> Totalizer Decimal Place<br/>0) 0.01<br/>1) 0.1<br/>2) <b>none</b><br/>3) x10<br/>4) x100</p> <p><b>7.</b> Ratemeter Units<br/>0) <b>Gallons</b><br/>1) Liters<br/>2) Pounds*<br/>3) Cubic Feet<br/>4) Cubic Meters<br/>5) Barrels<br/>6) Kilograms*<br/>7) Custom*</p> <p><b>8.</b> Ratemeter Decimal Place<br/>0) 0.001<br/>1) 0.01<br/>2) 0.1<br/>3) none<br/>4) x10<br/>5) x100<br/>6) <b>Auto-range</b></p> | <p><b>9.</b> Ratemeter Time-base<br/>0) Seconds<br/>1) <b>Minutes</b><br/>2) Hours<br/>3) Days<br/>4) Custom*</p> <p><b>10.</b> Enable 4-20mA Output<br/>4-20mA Output Low* <b>{0.0}</b><br/>4-20mA Output High *<br/><b>{99999.0}</b></p> <p><b>11.</b> Enable Pulse Output<br/>Pulse Width<br/>0) Frequency<br/>1) 1 ms<br/>2) <b>2 ms</b><br/>3) 5 ms<br/>4) 10 ms<br/>5) 50 ms<br/>6) 100ms<br/>7) Custom*<br/>Pulse Output Divider<br/>0) <b>1</b><br/>1) 2<br/>2) 5<br/>3) 10<br/>4) 50<br/>5) 100<br/>6) 1000<br/>7) Custom*</p> <p><b>12.</b> Backlight Timer<br/>0) Disabled<br/>1) 2s<br/>2) 5s<br/>3) <b>10s</b><br/>4) 30s<br/>5) 1m<br/>6) 3m<br/>7) 5m<br/>8) Always On<br/>9) Custom*</p> <p><b>13.</b> Power Mode Selection<br/>0) Mode 1 refresh 16/s<br/>1) Mode 2 refresh 8/s<br/>2) <b>Mode 3 refresh 4/s</b><br/>3) Mode 4 refresh 1/s<br/>4) Mode 5 refresh 2s</p> | <p><b>14.</b> Alarm Bits<br/>Low Battery<br/>Temperature Under<br/>Temperature Over<br/>Rate Under<br/>Rate Over<br/>No Totalize During Alarm</p> <p><b>15.</b> Service Hours<br/>Service Hours Set Point<br/>Service Hours Set Point<br/>Edit/Reset* <b>{1000}</b></p> <p><b>16.</b> Datalogger</p> <p><b>17.</b> Real-Time Clock</p> <p><b>18.</b> Warnings<br/>Flow Rate<br/>Low* <b>{0.0}</b><br/>High* <b>{9999999.2}</b><br/>Temperature<br/>Low* <b>{-350.0}</b><br/>High* <b>{200.0}</b><br/>Temperature Sample Delay<br/>0) 1s<br/>1) 2s<br/>2) 5s<br/>3) <b>10s</b><br/>4) 30s<br/>5) 1m<br/>6) 3m<br/>7) 5m<br/>8) 10m<br/>9) Custom*</p> <p><b>19.</b> Unit Test<br/>Raw Frequency<br/>RTD ohms<br/>DC Input / Battery Voltage (DC in if &gt; 2.7Vdc)<br/>LCD Test<br/>4-20mA Output Test %<br/>0) 0<br/>1) 25<br/>2) 50<br/>3) 75<br/>4) 100%<br/>Software Version</p> <p><b>20.</b> Enable Menu Lockout<br/>Menu Lockout Code*<br/><b>{1000}</b></p> |
|---|--|--|

\* User Editable value

Default values in **bold**. Your default values may be different depending on the configuration requested at order time.

## Appendix 2: Coefficient of Thermal Expansion for Common Fluids

### Fluid Properties Table

#### LIQUID

Fluid	Reference Density (Lb/Gal)	Reference Temperature (°F)	Coefficient of Thermal Expansion
Air	7.294	-317.8	0.0016262
Ammonia	5.699	-28.2	0.0005704
Argon	11.616	-302.6	0.0014861
CO <sup>2</sup>	8.733	-10.0	0.0012609
Methane	3.540	-258.7	0.0010523
Natural Gas	3.540	-258.7	0.0010523
Nitrogen	6.743	-320.4	0.0014917
Oxygen	9.519	-297.4	0.0013458
Propane	4.234	60.0	0.0007178
Gasoline	6.256	60.0	0.0003703
Kerosene	6.923	60.0	0.0002681
#2 Fuel Oil	7.883	60.0	0.0000885
Water	8.338	60.0	0.0001015

### Appendix 3: Menu Flow Chart

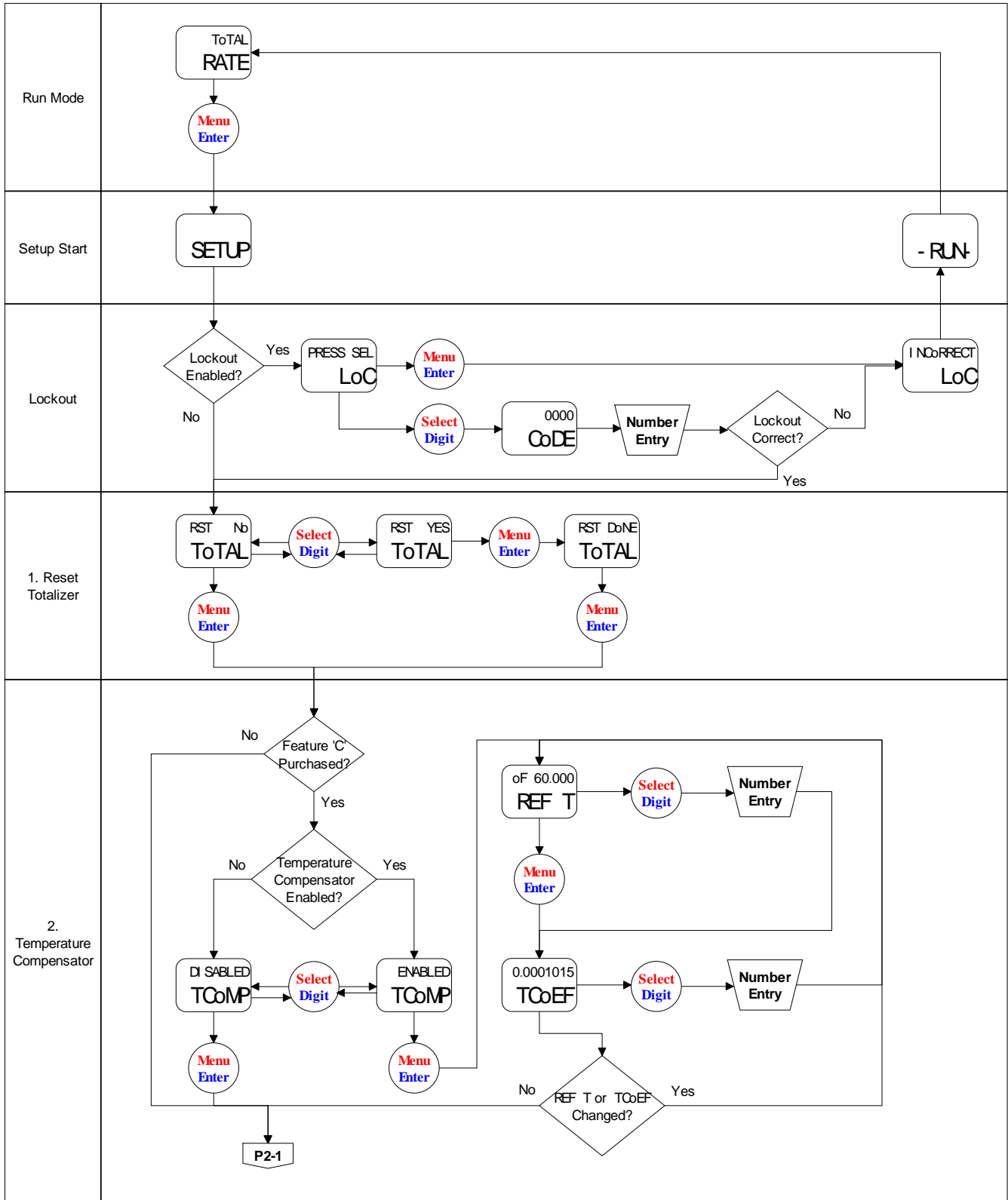

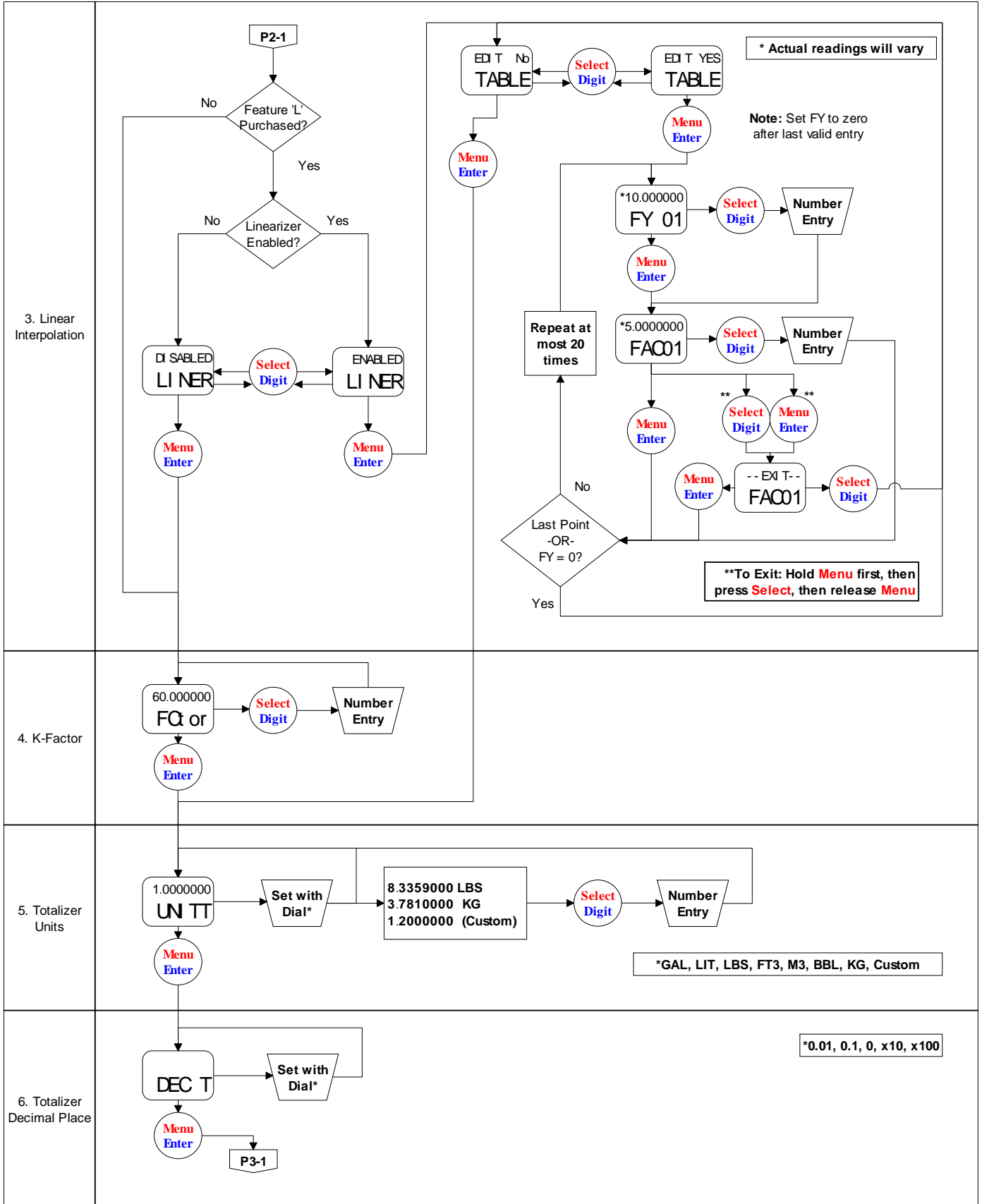

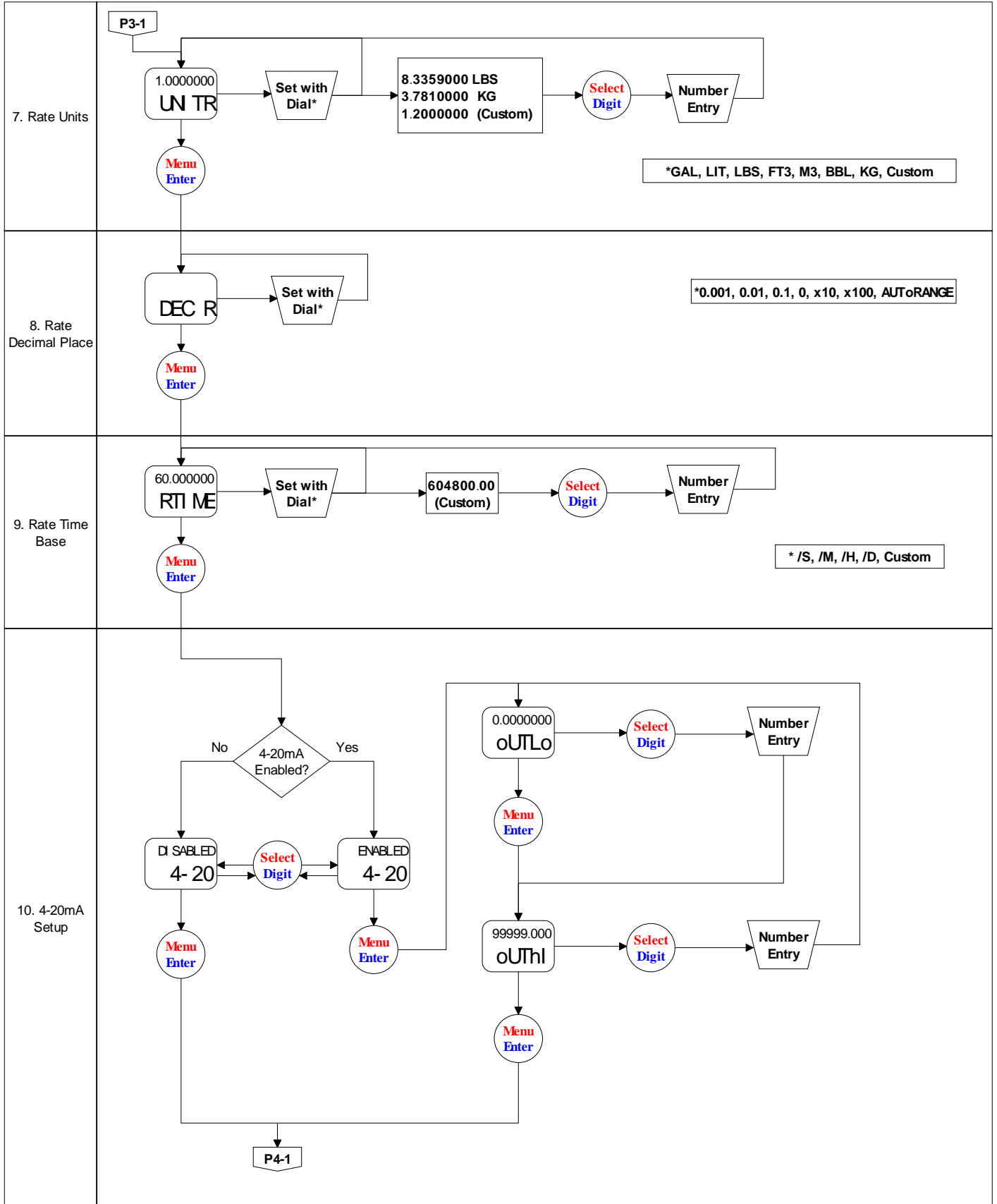

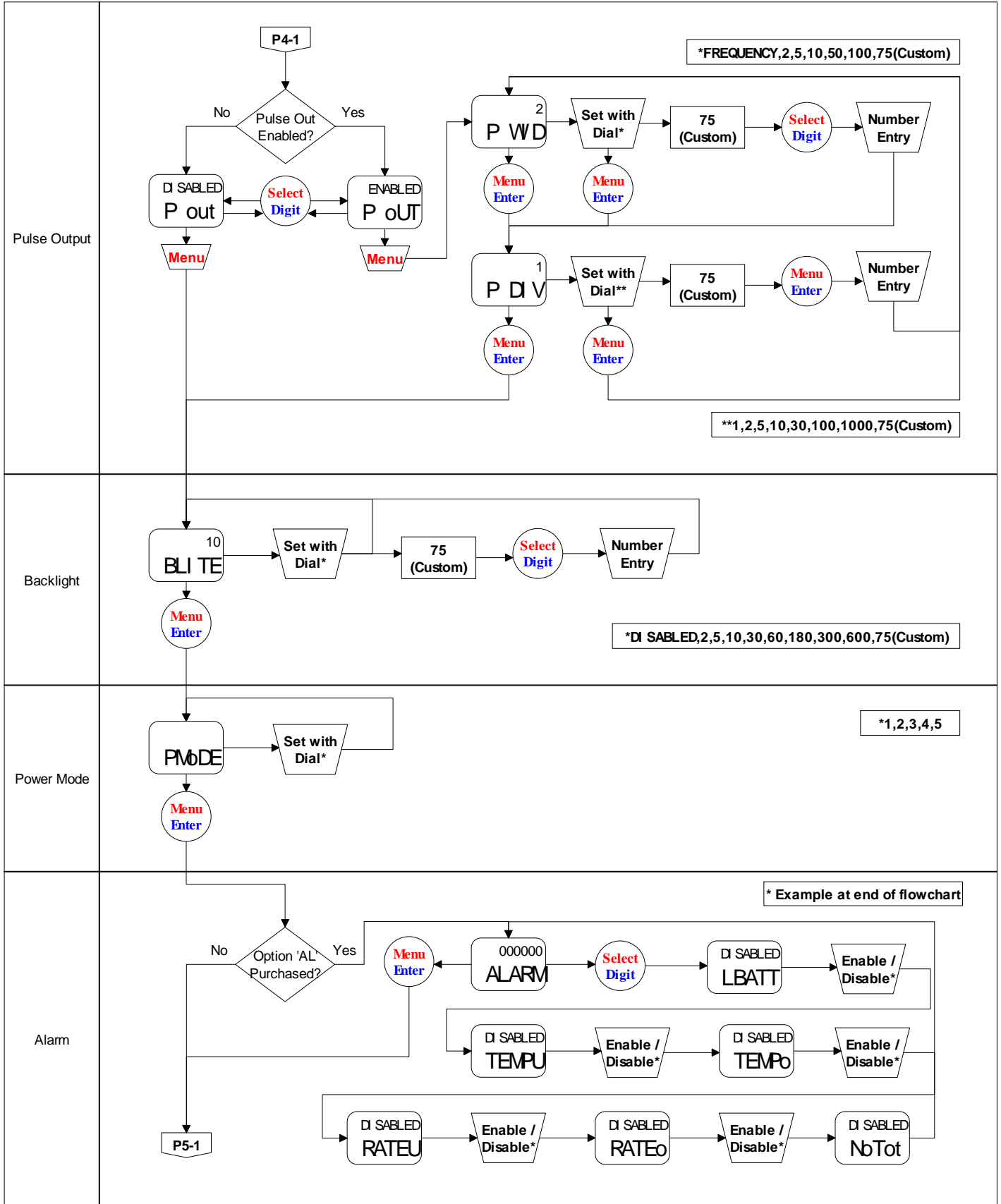

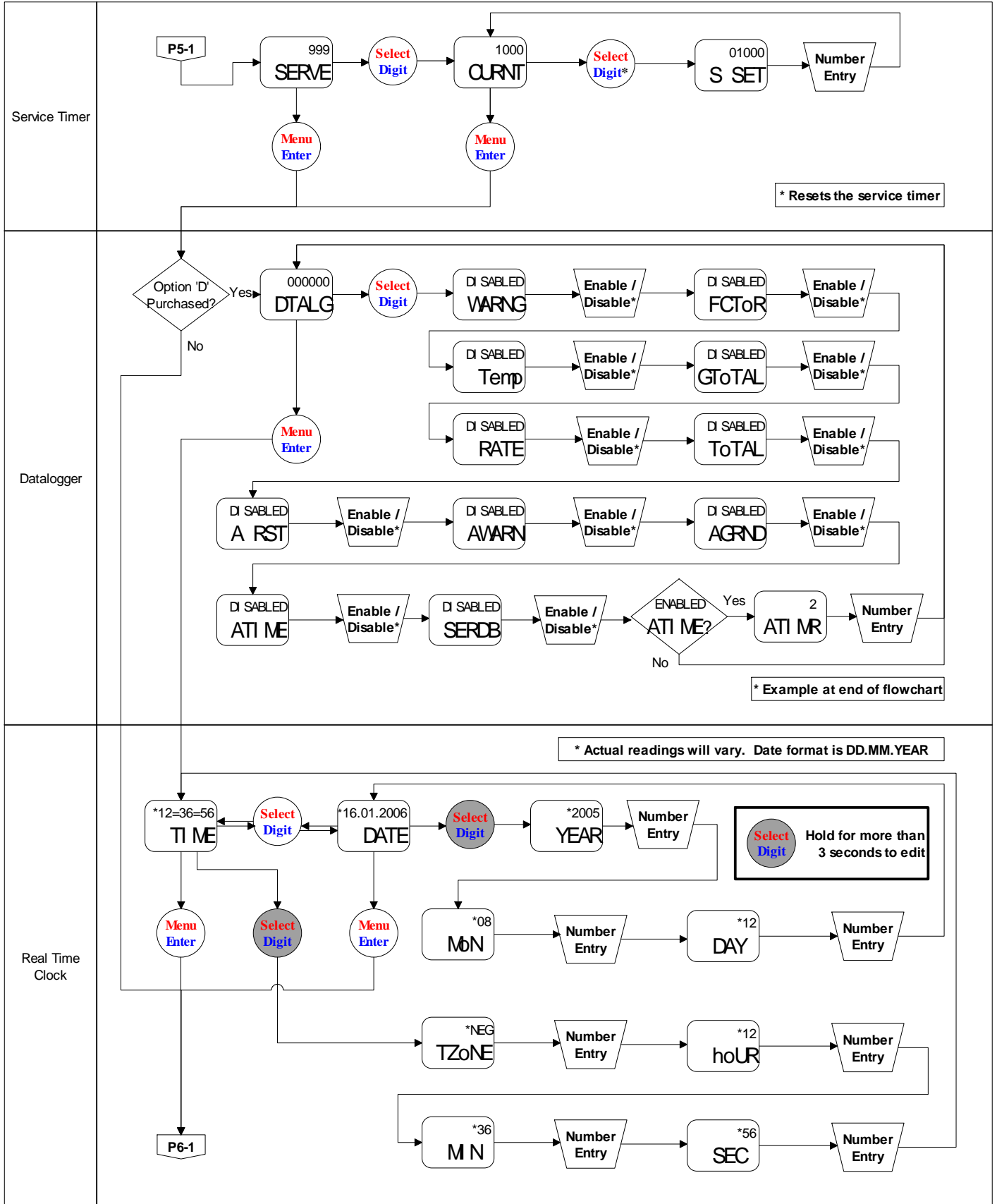

Warnings:  
Flow Rate and  
Temperature  
Setpoints

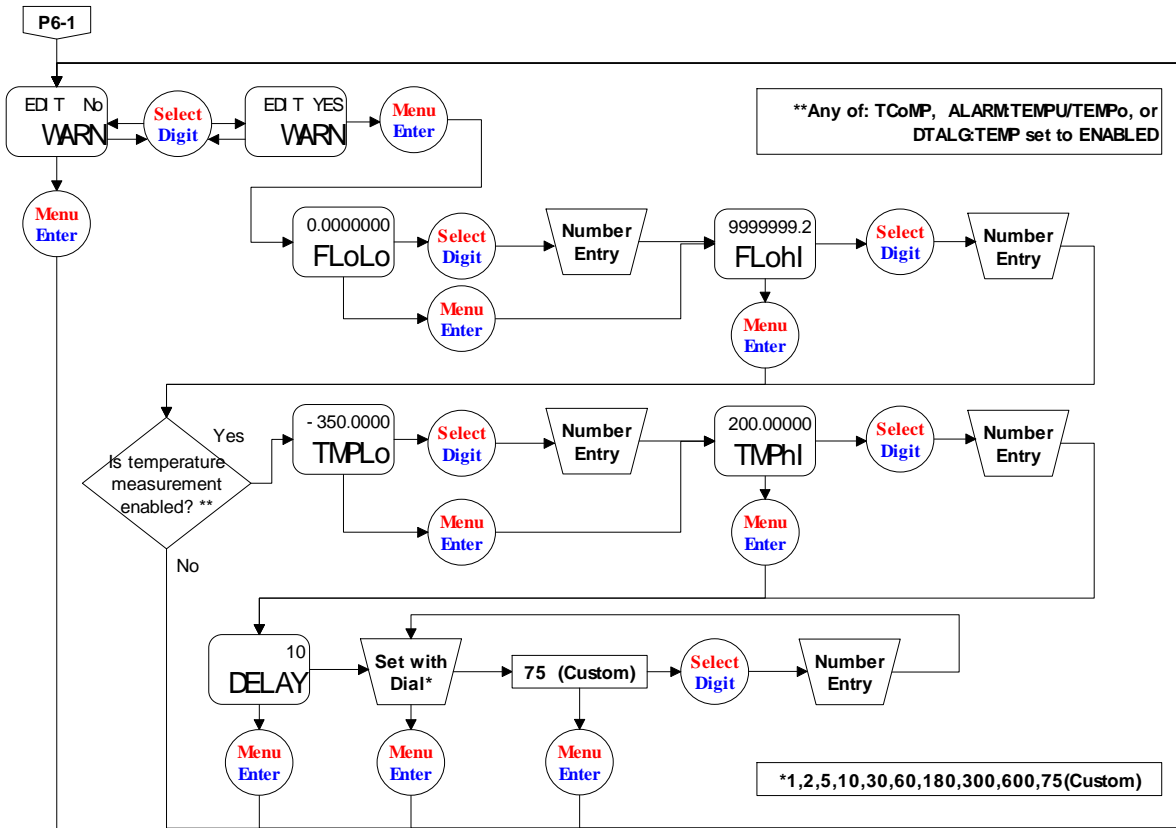

Test  
(Multimeter  
Functions)

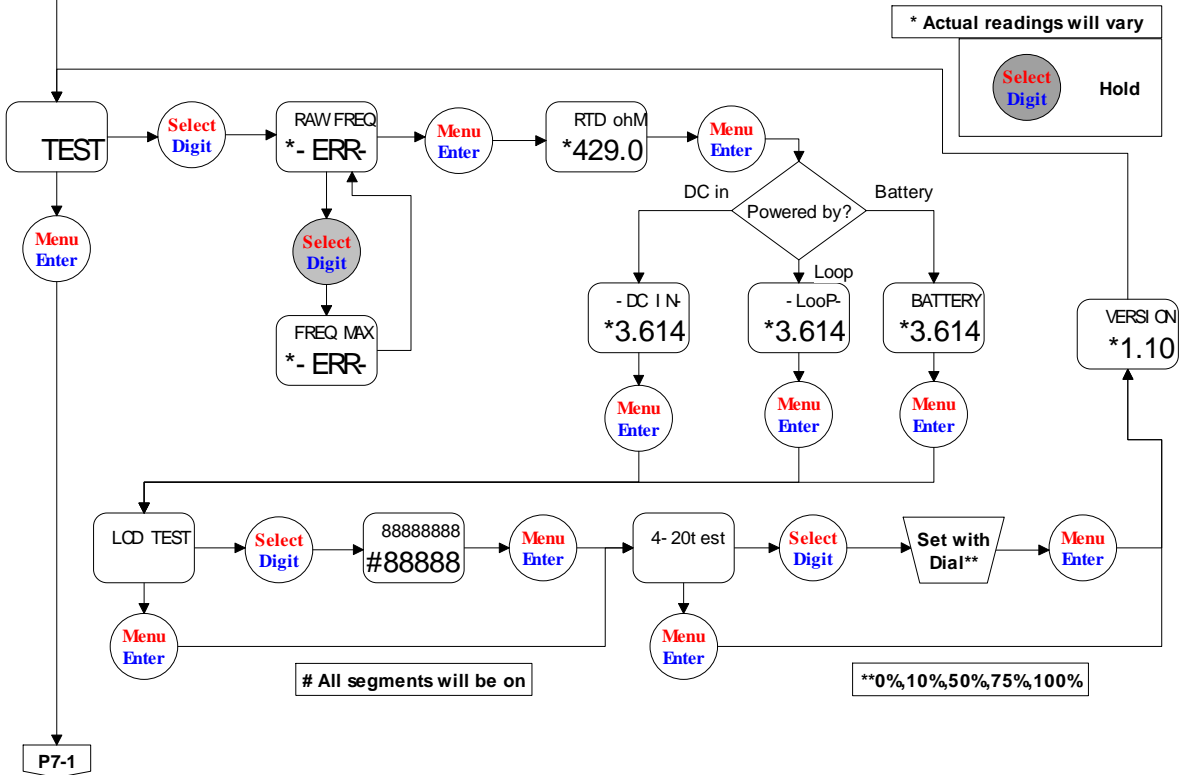

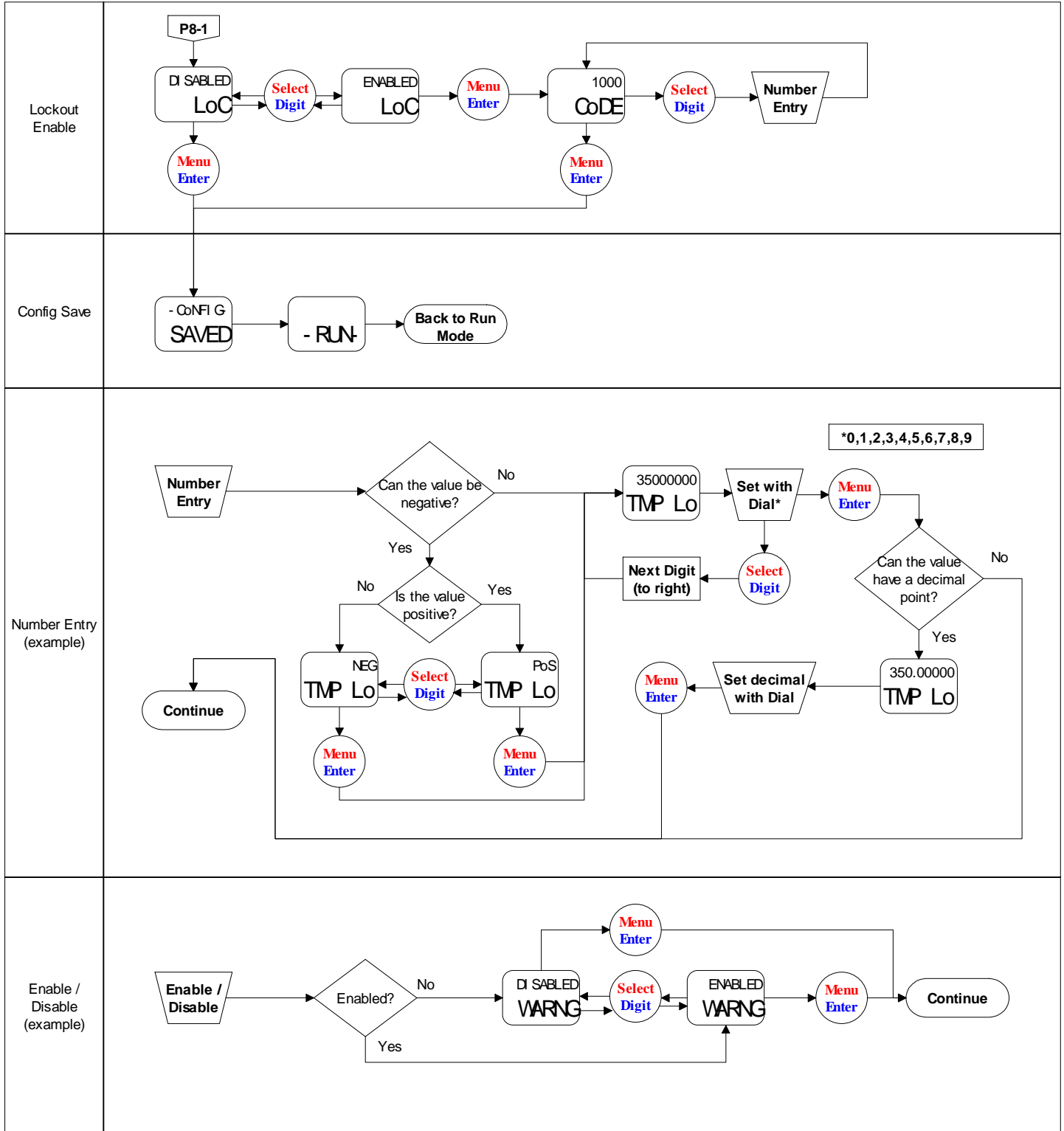

## Appendix 4: Manual Revision History

Revision	Date	Notes
Original	9/1/2004	Original Document
R1	6/15/2005	Revision level added (title); Copyright date updated (ii); Loop voltage limits added (2); Wire length limits and CE power limitations added (3); Alarm editing description added (18); FMax description, Backlight disabled during 4-20mA, and Version display added (19); Bold defaults and Version added (21); Converted the reference densities to LB/Gal (22); Added Version to test mode (28); Revision history added (29); Various formatting and editorial markups.
R2	1/17/2006	Added Datalogger and Real Time Clock sections to Operational Overview, Menu, Appendix 1, and Appendix 3. Changed warnings. Added front page image.
R2a	3/14/2006	Formatting corrections.
R2b	12/4/2007	Added backlight information: Backlight section of Operational Overview, Menu, and Appendix 1, Menu Quick Reference. Updated Copyright Added power to pulse and Alarm out. Added current to DC input.
R2c	3/18/2008	Update to CE Declaration of Conformity. Added DC input voltage tolerance and ATEX to specifications. Updated Assembly drawing. Note on wiring about screw depth and threads. Update branding.







# **LIQUID CONTROLS GROUP**

IDEAL SOLUTIONS      INTEGRATED SYSTEMS

**LIQUID CONTROLS EUROPE • LIQUID CONTROLS SPONSLER**

**LIQUID CONTROLS • LIQUID CONTROLS INDIA**

**FAURE HERMAN • TOPTECH SYSTEMS**

**CORKEN • SAMPI**



## **LIQUID CONTROLS**

105 Albrecht Drive  
Lake Bluff, IL 60044  
(847) 295-1050

## **TOPTECH SYSTEMS**

280 Hunt Park Cove  
Longwood, FL 32750  
(407) 332-1774

## **CORKEN**

3805 Northwest 36<sup>th</sup> St.  
Oklahoma City, OK 73112  
(405) 946-5576

## **LIQUID CONTROLS EUROPE/SAMPI**

Via Amerigo Vespucci 1  
55011 Altopascio (Lucca), Italy  
+39 0583 24751

Nateus Business Park  
Nieuwe Weg 1-Haven 1053  
B-2070 Zwijndrecht (Antwerp), Belgium  
+32 (0)3 250 60 60

## **LIQUID CONTROLS INDIA**

808 VCCI Complex  
GIDC Makarpura  
Vadodara-390 101  
Gujarat, India  
+91 265 2631855

## **FAURE HERMAN**

Route de Bonnetable  
B.P. 20154  
72406 La Ferté-Bernard Cedex, France  
+33 (0)2 43 60 28 60

6961 Brookhollow West Drive  
Houston, TX 77040  
(713) 623-0808

## **LIQUID CONTROLS SPONSLER**

105 Albrecht Drive  
Lake Bluff, IL 60044  
(847) 295-1050